

"This is the peer reviewed version of the following article: Klikar, M., Solanke, P., Tydlitát, J. and Bureš, F. (2016), Alphabet-Inspired Design of (Hetero)Aromatic Push–Pull Chromophores. *The Chemical Record*, 16: 1886–1905. doi:10.1002/tcr.201600032, which has been published in final form at <https://dx.doi.org/10.1002/tcr.201600032>. This article may be used for non-commercial purposes in accordance With Wiley-VCH Terms and Conditions for self-archiving".

This postprint version is available from <http://hdl.handle.net/10195/66348>

Alphabet-Inspired Design of (Hetero)Aromatic Push–Pull Chromophores

Milan Klikar,^[a] Parmeshwar Solanke,^[a] Jiří Tydlitát,^[a] and Filip Bures^{z*[a]}

ABSTRACT: Push–pull molecules represent a unique and fascinating class of organic π -conjugated materials. Herein, we provide a summary of their recent extraordinary design inspired by letters of the alphabet, especially focusing on H-, L-, T-, V-, X-, and Y-shaped molecules. Representative structures from each class were presented and their fundamental properties and prospective applications were discussed. In particular, emphasis is given to molecules recently prepared in our laboratory with T-, X-, and Y-shaped arrangements based on indan-1,3-dione, benzene, pyridine, pyrazine, imidazole, and triphenylamine. These push–pull molecules turned out to be very efficient charge-transfer chromophores with tunable properties suitable for second-order nonlinear optics, two-photon absorption, reversible pH-induced and photochromic switching, photocatalysis, and intercalation.

Keywords: chromophores, conjugation, donor–acceptor systems, photochemistry, structure–activity relationships

1. Introduction

Organic push–pull molecules represent a subclass of π -conjugated systems that are end-capped with electron donor(s) and electron acceptor(s). The D- π -A arrangement allows direct interaction of the donor (D) and the acceptor (A) through the π -system, so-called intramolecular charge transfer (ICT), and generates a new molecular orbital. The excitation of the electrons within the new orbital can be achieved by visible light, which gives push–pull molecules their color (charge-transfer (CT) chromophores). Apart from distinct optical properties, the ICT significantly polarizes the whole π -system and D- π -A molecules possess a dipolar character. The ICT can graphically be expressed by limiting resonance forms (Figure 1).^[1]

The main advantage of CT chromophores with the D- π -A arrangement over other inorganic and organic dyes can be seen in their well-defined and tunable structures and predictable properties. In principal, the fundamental features of push–pull molecules, such as the HOMO and LUMO levels and their difference (band gap), position of the longest-wavelength absorption maxima (CT band), and dipole moment, can be modulated by alternating the A, D, and π parts. Variation of the electron-withdrawing and -releasing behavior of A and D, modification of the π -system (length, composition, and polarizability), and overall chromophore arrangement (number and mutual arrangement of the A and D moieties, planarity, and further auxiliary functionalization) currently represent well-developed tools for tailoring D- π -A

systems towards desired applications.^[1,2] In this respect, the incorporation of a heteroatom into the π -conjugated backbone seems to be a newer, but also powerful strategy directed towards the modulation of optoelectronic properties. Six- and five-membered heterocycles, such as azines,^[3] thiophenes,^[4,5] and imidazoles,^[6] belong to the most widely employed heterocycles. Heteroaromatic compounds represent an alternative to hydrocarbon scaffolds, while the heteroatoms bring higher polarizability, as well as thermal and chemical robustness, and behave as auxiliary electron donors/acceptors, and constitute a place of further modification (acid/base and coordination properties).

From a historical point of view, the first push–pull organic molecules were used as dyestuffs, for example, the synthetic dye mauveine.^[7] After invention of the laser in 1960, D- π -A systems also became important media for nonlinear optics (NLOs).^[8] More recently, organic push–pull molecules have notably infiltrated materials chemistry, and organic electronics and optoelectronics currently represent well-developed and burgeoning areas.^[9] The concept of π -conjugated molecules with the D- π -A arrangement has been advantageously utilized in dye-sensitized solar cells (DSSCs),^[10] bulk-heterojunction solar cells (BHJSCs),^[11] organic light-emitting diodes (OLEDs),^[12] two-photon absorbers (2PAs),^[13] and near-infrared absorbing dyes.^[14]

In addition to the ordinary linear D- π -A systems, CT chromophores may also adopt advanced quadrupolar (D-(π -A)₂ or A-(π -D)₂) and tripodal (D-(π -A)₃ or A-(π -D)₃) arrangements. In recent years, extraordinary arrangements of push–pull chromophores inspired by letters of the alphabet appeared in the literature. Hence, based on these, as well as our contributions, we cover herein the design, properties, and further use of selected classes of such peculiar chromophores. In alphabetical order, these include H-, L-, T-, V-, X-, and Y-shaped molecules, as schematically shown in Figure 2. Most frequently, the letter shape corresponds to either π -conjugated

^[a]M. Klikar, P. Solanke, J. Tydlitát, F. Bures
Institute of Organic Chemistry and Technology,
Faculty of Chemical Technology
University of Pardubice
Studentská 573
Pardubice 53210 (Czech Republic)
E-mail: filip.bures@upce.cz

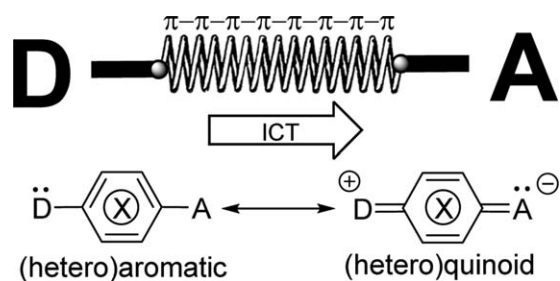

Fig. 1. Schematic representation of a D- π -A system and two limiting resonance forms of a (hetero)aromatic push-pull molecule (X=any heteroatom incorporated within the π -scaffold).

or non-conjugated chromophore backbones, whereas the electron acceptors and donors are attached to the periphery.

2. H-Shaped Molecules

Undoubtedly, H-shaped molecules represent one of the most extraordinary arrangements of push-pull molecules known to date. Three general classes of H chromophores with different A and D arrangements along the H-shaped backbone can be found in the current literature: 1) two parallel D- π -A units

connected by a (non)conjugated spacer, 2) two bridged upside-down D- π -A systems, and 3) H-shaped core bearing a central electron-withdrawing moiety and four peripheral donors.

The first class of H-shaped chromophores was extensively investigated by Zhang et al. (Figure 3).^[15] 9,10-Dihydroanthracene has been utilized as a central π -conjugated core with hydroxy/alkoxy electron donors appended at positions C4/C5 and acceptors linked through azo spacers at C1/C8. Target push-pull molecules **1** and **2** were synthesized in a two-step reaction sequence through a key intermediate, 1,8-dihydroxy-9,10-dihydroanthracene, which was prepared from 1,8-dihydroxy-9,10-anthraquinone, followed by azo-coupling. Compared with analogous linear push-pull chromophore **1a**, two parallel D- π -A units, as in **1**, showed a remarkably enhanced second-order NLO response, which was not accompanied by a large redshift of the longest-wavelength absorption maxima (nonlinearity-transparency trade-off; Table 1). Chromophore **2** embedded into a fluoro-containing aromatic main-chain PI afforded NLO-active organic material **3** with a high macroscopic nonlinearity, d_{33} , exceeding 70 pm/V, optical transparency above 400 nm and good thermal stability ($T_g=198^\circ\text{C}$, $T_d=245^\circ\text{C}$). Lu et al. further used the 9,10-

Milan Klikar was born in Turnov, Czech Republic (1988), and studied organic chemistry at the University of Pardubice (2007–2013), and is currently pursuing doctoral studies under the guidance of F. Bureš. In 2014, he joined the Institute of Organic Chemistry as a Scientific Researcher. His main research interests involve the synthesis and characterization of novel NLO-active materials, especially focusing on malonic acid derivatives, as well as the thermal behavior of organic π -systems.

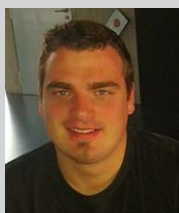

Parmeshwar Solanke was born in India, in 1982. He received his Master's degree in organic chemistry from The Swami Ramanand Teerth Marathwada University Nanded (India). He received his PhD in 2015 from the University of Pardubice under the supervision of F. Bureš. Before starting his doctoral studies, he worked as a Research Assistant at the National Chemical Laboratory, Pune (India). His research interests include the synthesis, properties, and applications of novel materials for nonlinear optics, organic solar cells (DSSCs), and organic light-emitting diodes (OLEDs).



Jiří Tydlitát was born in Pardubice, Czech Republic (1982), and studied chemistry at the University of Pardubice (2002–2008). He received his PhD in organic chemistry (2008–2014) from the University of Pardubice. He worked as a (post)doctoral fellow in the groups of G. Mlostoń (University of Łódź, Poland, 2011) and P. Sadler (University of Warwick, UK, 2015). He currently works as an Assistant Professor at the Institute of Organic Chemistry. His research is focused on polycyclic (hetero)aromatics as basic building blocks for novel fluorophores and NLO materials.



Filip Bureš was born in Poprad, Slovakia (1979), and studied chemistry at the University of Pardubice (1997–2002). He received his PhD in organic chemistry (2003–2005) from the University of Pardubice, where he was also habilitated in 2010. He pursued (post)doctoral studies with Prof. P. Knochel (LMU, Munich) and Prof. F. Diederich (ETH, Zurich). He currently leads his own working group at the Institute of Organic Chemistry, University of Pardubice, which focuses on the design and synthesis of π -conjugated molecules for miscellaneous optoelectronic applications.



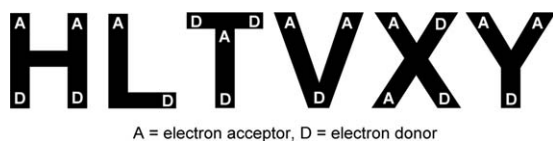

Fig. 2. Alphabet-inspired design of push-pull molecules.

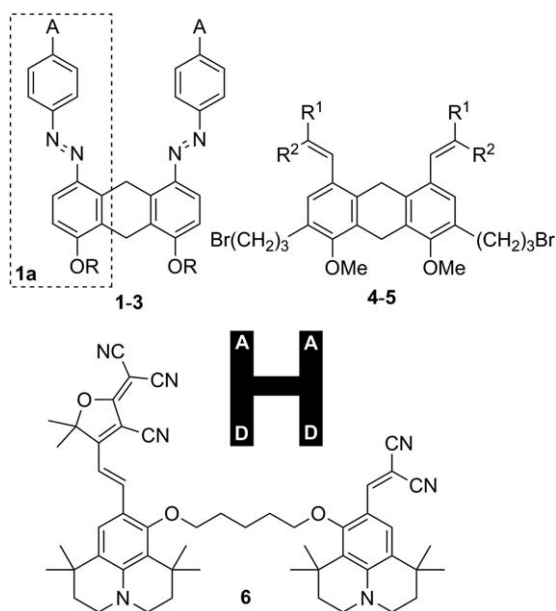

Fig. 3. H-shaped push-pull molecules with two parallel D- π -A units.

Table 1. Fundamental properties of chromophores 1–5.

	R/R ¹	A/R ²	λ_{\max} [nm] ^[a]	NLO properties
1a	H	NO ₂	388	70/28 ^[b]
1	H	NO ₂	398	277/105 ^[b]
2	H	CF ₃	367	252/117 ^[b]
3	PI	CF ₃	353 ^[c]	70.2 ^[d]
4	H	NO ₂	332	4151 ^[e]
5	CN	CN	332	1538 ^[e]

[a] Measured in THF. [b] First hyperpolarizability (β)/static first hyperpolarizability (β_0) measured in THF by hyper-Rayleigh scattering at 1064 nm versus *p*-nitroaniline (in 10^{-30} esu). [c] Measured in poled thin polyimide (PI) films. [d] Macroscopic second-harmonic coefficient, d_{33} (in pm/V). [e] $\mu\beta$ product determined by solvatochromic method versus *p*-nitroaniline (in 10^{-48} esu).

dihydroanthracene parent scaffold for the construction of chromophores 4 and 5, bearing methoxy donors and nitro and dicyanovinyl (DCV) acceptors (Figure 3 and Table 1).^[16] In a very similar way as that discussed above, they demonstrated that H-shaped chromophores possessed significantly improved optical nonlinearities over mono D- π -A systems. Interesting H-shaped chromophore 6 was prepared by Zhen et al.^[17] This

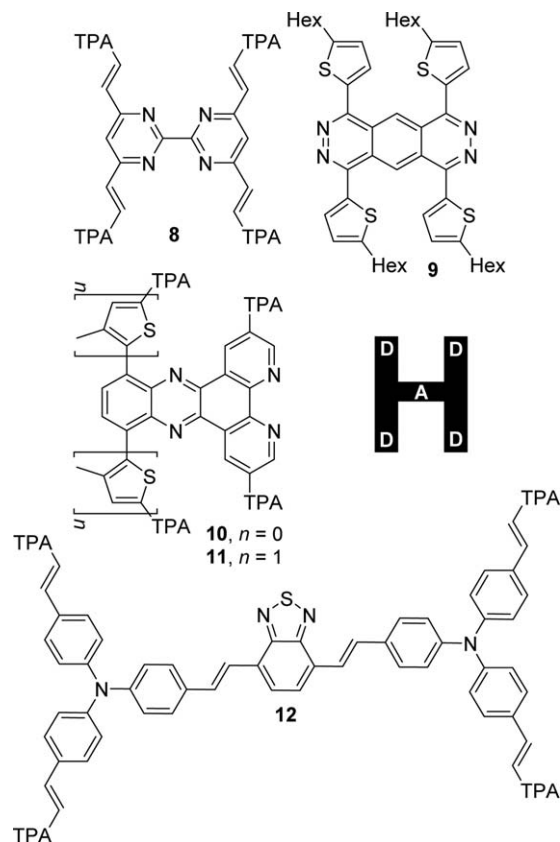

Fig. 4. H-shaped push-pull molecules 8–12 with a central acceptor and peripheral donors (TPA=4-diphenylanilino).

molecule contains two julolidine donors saturating two different electron acceptors (tricyanofuran (TCF) and DCV) across two different π -linkers. NLO measurements of unsymmetrical 6 embedded into polycarbonate showed improved poling efficiency, which was due to a reduced intermolecular dipole-dipole interaction (also supported by DFT calculations).

The concept of two D- π -A azobenzenes cross-linked through a spacer into H-shaped molecules has recently also been utilized in polymer chemistry.^[18] In this respect, various dendron-like, oligomeric, (hetero)aromatic, and aliphatic spacers and polymeric backbones were introduced by Li et al. It has been shown that such H-shaped chromophore embedding leads to polymeric materials with an enhanced NLO effect, optical transparency, and chemical and thermal robustness.

In contrast to previous H-shaped chromophores, the anti-parallel arrangement of two linked D- π -A units is much scarcer, most likely due to tedious synthesis. In 2014, Dong et al. reported on push-pull tetraarylbuta-1,3-diene 7 (Figure 4), with aggregation-enhanced emission and mechanotronic fluorescence properties.^[19] Among others, the D- π -A H-shaped arrangement turned out to be the most beneficial

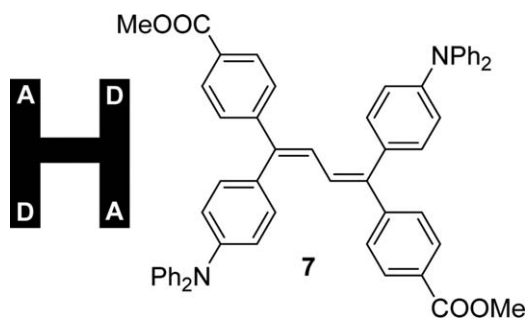

Fig. 5. H-shaped push-pull molecule **7** with two antiparallel D- π -A units.

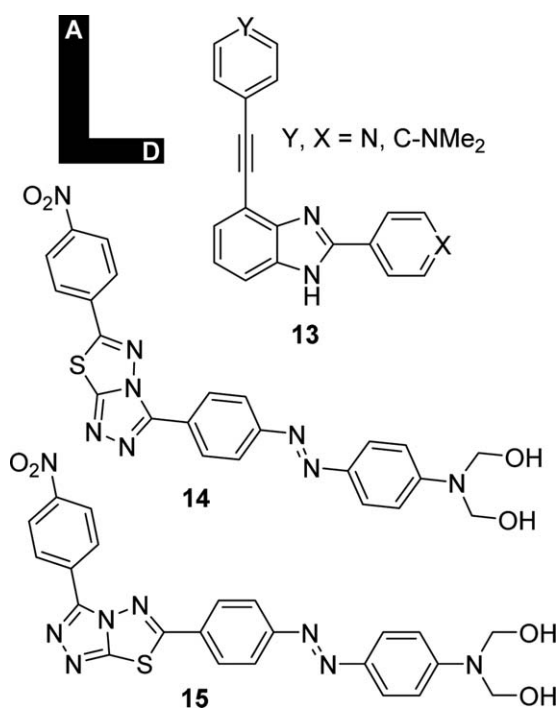

Fig. 6. L-shaped push-pull molecules **13–15** with benzo[*d*]imidazole and *s*-triazolo[3,4-*b*]thiadiazole cores.

by providing the molecule with a large dipole moment, mechanochromic contrast, and high solid-state fluorescence quantum yield.

The third group of H-shaped molecules with a central acceptor unit end-capped with four peripheral electron donors is shown in Figure 5. In these molecules, the central π -conjugated scaffold is often based on heterocyclic moieties, such as bipyrimidine (**8**),^[20] 2,3,6,7-tetraazaanthracene (**9**),^[21] dipyrrodo[3,2-*a*:2',3'-*c*]phenazine (**10** and **11**),^[22] and 2,1,3-benzothiadiazole (**12**).^[23] Bipyrimidine **8** has been investigated as a D_{2d} octupolar chromophore with a large second-order nonlinear optical response ($\beta/\beta_0=190/130 \times 10^{-30}$ esu, measured by harmonic light scattering at 1640 nm

in CHCl_3), tetraazaanthracene **9** showed typical n-type characteristics and could be considered as a promising candidate for organic electronic devices. In phenazines **10** and **11**, the ICT can easily be tuned by extending the π -system with thienylene units ($n=0$ or 1). These chromophores showed outstanding thermal stability (T_{d10} over 500°C) and were suggested as organic materials suitable for OLEDs, DSSCs, and organic field-effect transistors (OFETs). Branched benzothiadiazole derivative **12** emitted red light, with $\lambda_{\text{max}}^{\text{E}}=621$ nm, with a fluorescence quantum yield of 33% and showed a two-photon absorption cross-section, $\delta_{2\text{PA}}$, of 351 GM (820 nm).

3. L-Shaped Molecules

Selected heterocyclic moieties can also be employed as central π -backbones for the construction of L-shaped push-pull molecules. Figure 6 shows two examples based on benzo[*d*]imidazoles (**13**)^[24] and *s*-triazolo[3,4-*b*]thiadiazoles (**14** and **15**).^[25] “Half-cruciforms” **13** could easily be synthesized in a two-step reaction sequence and were used as fluorophores that significantly responded to/sensed various bases, acids, and anions, depending on the orientation of the *N,N*-dimethylamino donor and pyridine acceptor.

In 2009, Centore et al. introduced triazolothiazole as a new central heteroaromatic scaffold for the construction of NLOphores **14** ($\lambda_{\text{max}}=469$ nm (DMF); $\mu\beta=430 \times 10^{-48}$ esu (EFISH, 1900 nm, DMF)) and **15** ($\lambda_{\text{max}}=489$ nm (DMF); $\mu\beta=980 \times 10^{-48}$ esu (EFISH, 1900 nm, DMF)).^[25] As can be seen, a proper orientation of the donor/acceptor around the parent heterocyclic core redshifts the longest-wavelength absorption maxima by 20 nm and more than doubles the NLO response.

4. T-Shaped Molecules

T-shaped chromophores represent another extraordinary structural arrangement of push-pull molecules. Several (hetero)aromatic π -backbones were utilized to construct such molecules. In 2013, we showed the first systematic modification of an indan-1,3-dione-fused benzene ring through cross-coupling reactions, leading to T-shaped chromophores **16**.^[26] The straightforward synthetic pathway starts from inexpensive phthalic anhydride and its gradual iodination, Claisen condensation with ethyl-acetoacetate, and decarboxylation afforded 4,7-diiodoindan-1,3-dione as an intermediate capable of further Knoevenagel condensation and cross-coupling reaction (Scheme 1). In this modular way, various lower and peripheral electron donors can be attached to the central indan-1,3-dione acceptor to generate 16 tripodal (D- π)₂-A- π -D molecules with systematically modified electron donors (D) and the π -system length (n). These structural modifications allowed tuning of

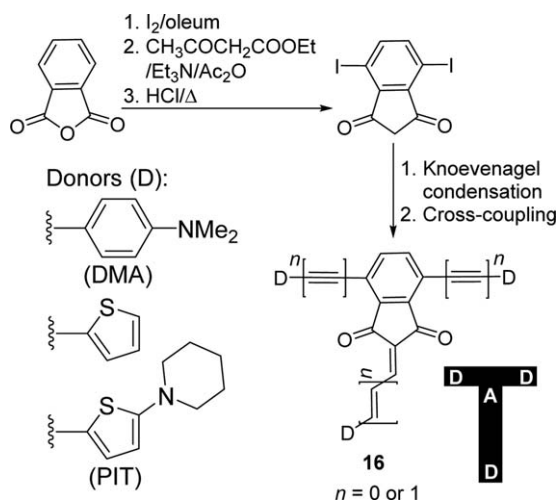

Scheme 1. Structure and synthesis of T-shaped chromophores **16** based on an indan-1,3-dione central acceptor moiety.

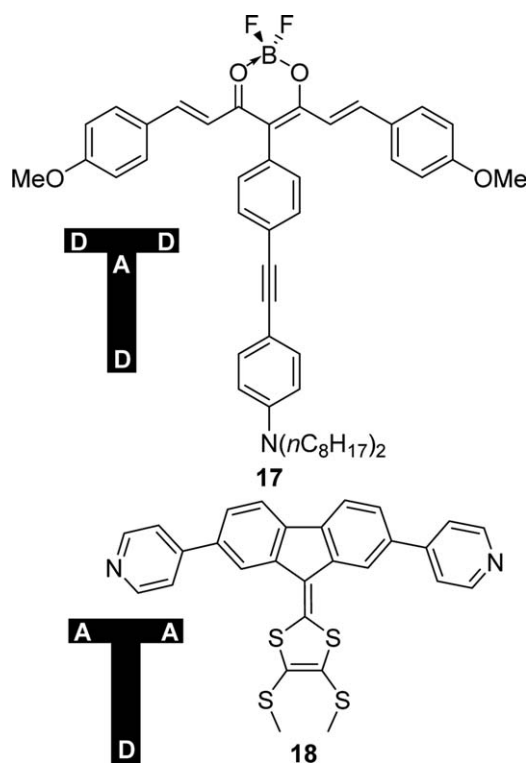

Fig. 7. Tripodal T-shaped chromophores **17** and **18** with $(D-\pi)_2-A-\pi-D$ and $(A-\pi)_2-D$ arrangements.

the electrochemical/optical gaps within the range of 2.13–1.43/2.55–1.93 eV and provided optical nonlinearities with $\mu\beta = 230\text{--}2100 \times 10^{-48}$ esu (EFISH, 1907 nm, CH_2Cl_2).^[27] It turned out that the lower electron donor was involved in more-efficient ICT than the peripheral ones.

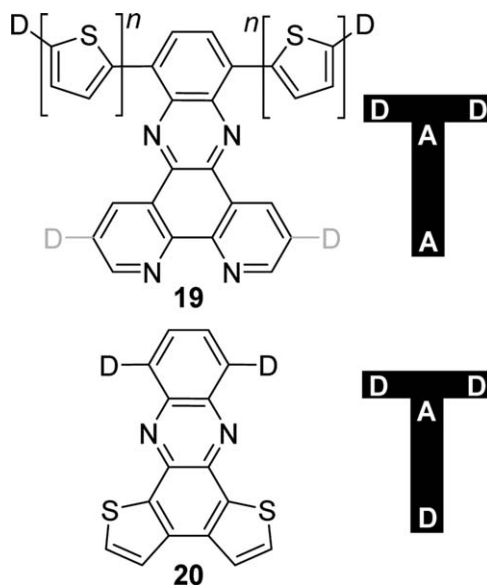

Fig. 8. Phenazine-derived CT chromophores **19** and **20**.

Fages et al. utilized 1,3-dicarbonyl compounds as part of the electron-withdrawing dioxaborine moiety in **17** (Figure 7) saturated by three peripheral methoxy and dialkylamino donors.^[28] Spectral investigations of this molecule revealed photoinduced ICT from the peripheral branches, resulting in two closely lying excited states with the possibility of controlling the ICT through solvent, protonation, and complexation. 9H-Fluorene can also be used as a parent hydrocarbon scaffold for the construction of CT chromophore **18** (Figure 7) equipped with two accepting pyridin-4-yl moieties and a 1,3-dithiolo donor.^[29] The extent of ICT was investigated by X-ray analysis, electrochemistry, electronic absorption spectra, and was completed by DFT calculations.

Heteroaromatic phenazine is probably the most often employed π -backbone for the construction of T-shaped molecules bearing a central acceptor moiety. Figure 8 shows two representative derivatives, **19** and **20**, with a lower bipyridine acceptor or bithiophene donor and two peripheral donors D (TPA, carbazole, and 4-methoxyphenyl). Positioning of the D along the π -conjugated core of **19** significantly affected the absorption and emissive properties, as well as thermal stability. Moreover, due to a $N=C-C=N$ (bipy) binding pocket in **19**, these chromophores can also be used as auxiliaries to chelate $Ru(II)$.^[30] The latter type of chromophores **20** showed structured absorption covering almost the whole range of visible light, provided red emission, and could grow into straight microwires in DCM/ethanol.^[31] In particular, chromophore **20** equipped with TPA donors showed a high fluorescence quantum yield, large Stokes' shift, and low optical loss coefficient of 0.29 dB/ μm , and therefore, could be considered as a promising red-emitting waveguide material. In general,

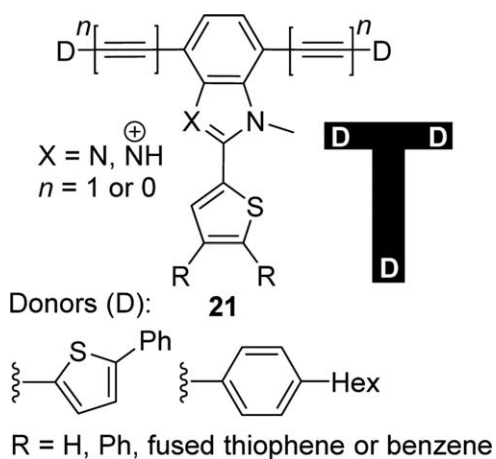

Fig. 9. T-shaped molecules **21** built on the benzo[*d*]imidazole core.

phenazine-derived T-shaped molecules proved to be chromophores well suited for tuning and controlling the ICT,^[32] particularly when going to more extended bisphenazines.^[33] For instance, T-shaped bisphenazines were thoroughly investigated by Lee et al. as self-assembling molecules or organogelators.^[34]

Apart from six-membered diazines, benzo[*d*]imidazole can also be employed as a central heteroaromatic scaffold for the construction of either L-shaped half-cruciforms **13** (Figure 6) or T-shaped chromophores. For instance, Nakashima et al. published a series of papers focusing on 2,4,7-trisubstituted benzo[*d*]imidazole tripodal derivatives **21** (Figure 9).^[35] In these molecules, the central benzo[*d*]imidazole was primarily used as an acid-responsive core, which upon protonation only redshifted the emission maxima without significantly affecting the position of the absorption CT band. In contrast to analogous linear chromophores, T-shaped **21** showed twisted intramolecular charge transfer (TICT), and therefore, orthogonally allocated branches at positions C4 and C7 seemed to be essential for the emergence of TICT. A vertical π -system with higher quinoid character generally suppressed the TICT emission, leading to a more planar ICT state. Benzimidazolium T-shaped molecules were also utilized as a new templating motif for the formation of [2]pseudorotaxanes, in which the T-shape arrangement greatly enhanced the association with crown ethers when compared with simple linear analogues.^[36]

Some other spiro- and carbazole-derived T-shaped push-pull molecules appeared in the literature, with applications ranging from photoinduced switches to amphiphilic molecules.^[37,38]

5. V-Shaped Molecules

V-shaped push-pull molecules (also referred to as U- or Λ -shaped) appear in the current literature much more often

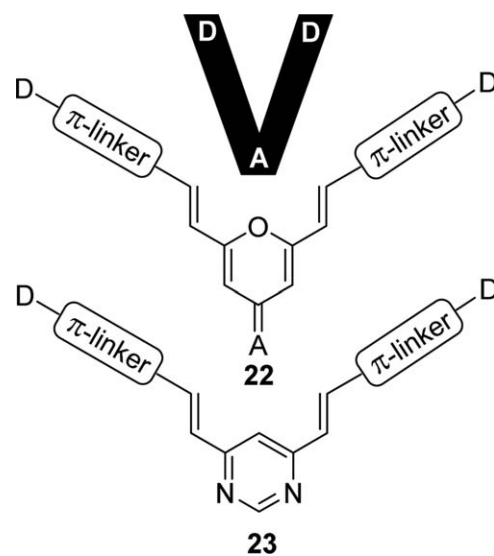

Fig. 10. Pyran- and diazine-derived V-shaped push-pull molecules.

than the previous three series. Hence, in the following section, the most common structural motives used for their construction, such as pyran, pyridine, diazines, (di)azinium salts, carbazole, and others, are summarized. Pyran belongs to one of the most widely employed heteroaromatic compounds used as either proaromatic electron donor or π -conjugated central moieties (Figure 10; **22**).^[39] Whereas electron donors in **22** are mostly connected at the positions C2 and C6, electron-withdrawing moieties are introduced at the position C4 through a Knoevenagel reaction. The electron-releasing moieties (D) comprise *N,N*-dialkyl(aryl)amines, indole, carbazole, and proaromatic 4*H*-pyran-4-ylidene; the A part is represented by the strongest electron-withdrawing moieties, such as DCV, (thio)barbituric acid, isoxazolone, and TCF. The π -system is often extended through polarizable 2,5-thienylene linkers.^[40] It turned out that the central pyranidene moiety behaved strictly as a polyenic spacer, not as an auxiliary donor, unlike the pyranidene terminal donor. Moreover, both C2/C6 branches can be unsymmetrically substituted, which further improves the second-order NLO response and such quadrupolar molecules possess absorption maxima reaching 700 nm with large intrinsic hyperpolarizabilities, $\beta/\mu\beta$, up to $490/7160 \times 10^{-30/48}$ esu (HRS or EFISH experiments). Perspective applications of such powerful CT chromophores range from solvent probes to optic modulators, frequency doublers, and electro-optic polymers.

A very similar structural pattern to **22** can also be built on 2,6-disubstituted pyridine.^[41] Moreover, the presence of a basic pyridine nitrogen atom predestines such molecules to be used as pH-sensitive chromophores; the absorption maxima of which undergo significant redshift upon protonation (the ICT enhancement via pyridine to pyridinium acceptor

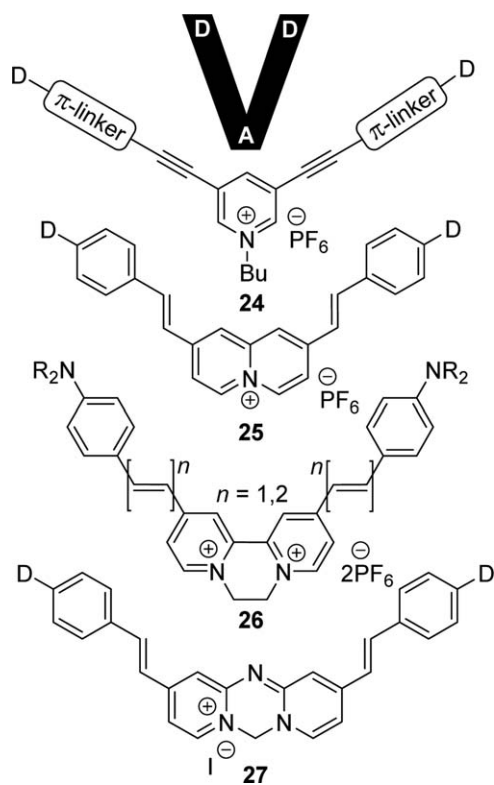

Fig. 11. Cationic V-shaped chromophores based on various azinium ions.

replacement). The concept of using a central (di)azine acceptor moiety for V-shaped push-pull molecules has recently been extended and reviewed by Achelle et al.^[3a,b] For instance, 4,6-bis(arylvinyl)pyrimidines **23** proved to be promising CT chromophores with facile synthesis and tunable optical properties.^[42] By a proper selection of the peripheral donor groups and solvents, the absorption and emission maxima can be shifted over 200 nm. Various applications of such derivatives were demonstrated, ranging from second-order NLOs, colorimetric and luminescent pH sensors, ion sensing, and halochromic materials. In particular, 4-(*N,N*-diphenylamino)-phenyl- and 6-methoxynaphthalen-2-yl-substituted derivatives proved to be efficient 2PAs with a very high δ_{2PA} of 5093 GM (800 nm)^[43] and material suitable for white organic light-emitting diodes (WOLEDs).^[44] Further modification of the diazine V-shaped chromophores can be achieved by linking topology,^[45] ketonization (e.g., pyrimidone),^[46] fusing with an additional (hetero)aromatic ring (e.g., quinazoline, naphthyridine, bipyridine, hexaazatriphenylene – HAT),^[47] and quaternization. The last approach leads to cationic chromophores, such as pyridinium **24**,^[48] quinolizinium **25**,^[49] bipyridinium **26**,^[50] or azacyanines **27** (Figure 11).^[51]

In general, N-quaternization of azines to azinium improves its electron-withdrawing ability, which subsequently enhances the D–A interaction (ICT). It further makes the

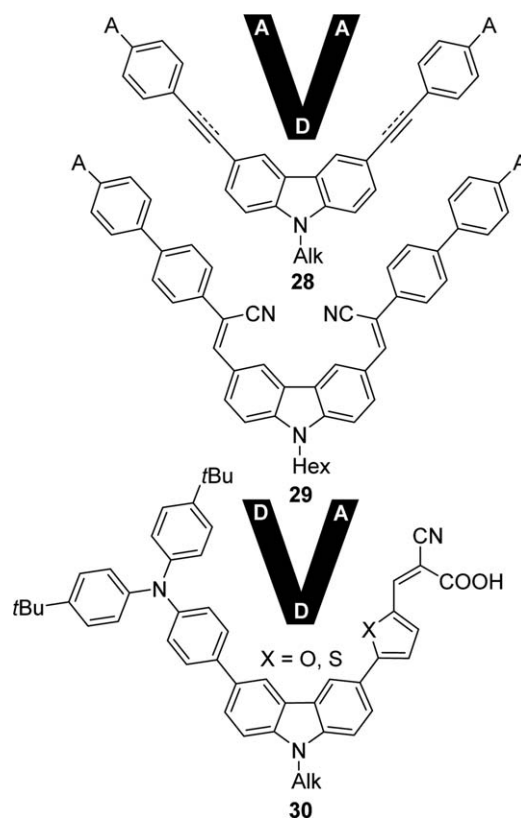

Fig. 12. Carbazole-derived V-shaped push-pull molecules for NLO and DSSC applications.

chromophore crystalline, soluble in polar solvents (hydrophilic), and improves its thermal stability.^[52] Hence, in contrast to azine analogues, azinium chromophores generally possess bathochromically shifted absorption and emission maxima, lower HOMO–LUMO gaps, and larger optical nonlinearities (e.g., large 2PA activity and strong fluorescence of **25** and **27**).

In addition to the aforementioned six-membered heterocycles, V-shaped push-pull molecules were also built on some five-membered heteroaromatic compounds, such as carbazole, with a central pyrrole moiety. In contrast to electron-poor azine and azinium moieties, carbazole is employed as a central electron donor commonly equipped with two branches at positions C3/C6. For instance, Hsiue et al. investigated a series of carbazole V-shaped derivatives **28** (Figure 12) as two-dimensional chromophores with large second-order molecular polarizabilities, which could be translated into macroscopic nonlinearity upon embedding the chromophore into polymeric matrix.^[53] Derivatives **28** with acetylenic spacers and peripheral formyl and nitro acceptors showed sufficient 2PA activity that allowed their use as two-photon polymerization initiators.^[54] Either symmetrically or asymmetrically substituted carbazole D-(π -A)₂ molecules **29** and **30**, bearing

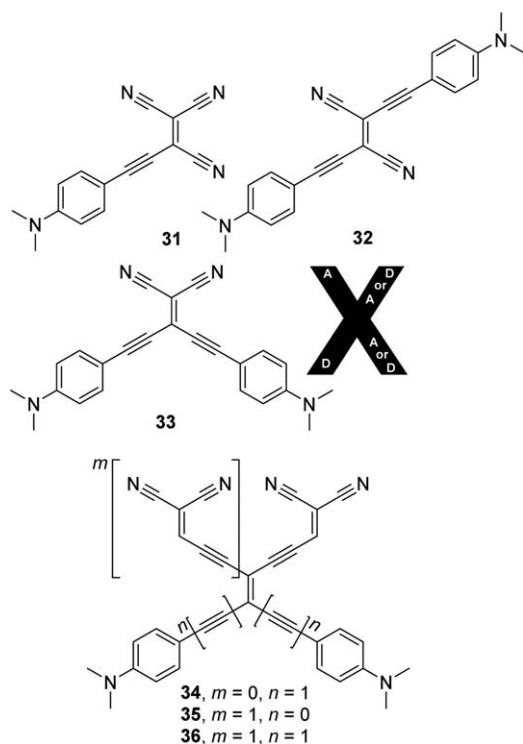

Fig. 13. Cyanoethynylethene (CEE) push-pull X-shaped chromophores with various number/arrangement of the donors and acceptors around the central ethene.

cyanoacrylic acid or rhodanine-3-acetic acid anchoring/acceptor groups (A), also found application as dyes suitable for DSSCs. A DSSC device based on these organic materials showed overall conversion efficiencies of 2.37 and 6.68%, respectively.^[55] In addition to optoelectronic applications, Shanguan et al. showed that carbazole V-shaped molecules with two peripheral benzo[*d*]imidazole rings interact with G-quadruplex, and therefore, may act as potential chemotherapeutics.^[56]

Similarly to carbazole D- π -D- π -A derivatives **30**, five-membered thiazazole was also utilized as a parent heteroaromatic π -backbone for the construction of V-shaped sensitizers for DSSCs. Employing various anchoring groups, a conversion efficiency of up to 4.12% can be achieved.^[57] Properly functionalized V-shaped oxazoles/thia(di)azoles or bisarylmalimides possess mesomorphic properties or aggregation-induced enhanced emission (AIEE) and polymorphism-dependent fluorescence, as recently demonstrated by the groups of Lehman^[58] or Lin.^[59]

6. X-Shaped Molecules

Push-pull molecules adopting an X-shape belong to traditional organic D- π -A systems. These molecules consist of four

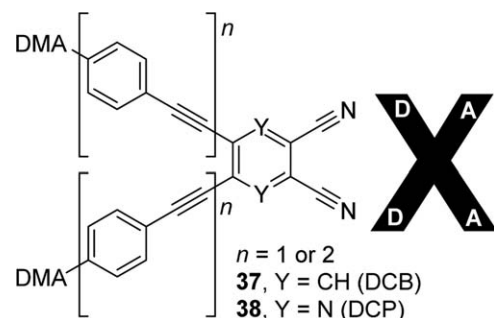
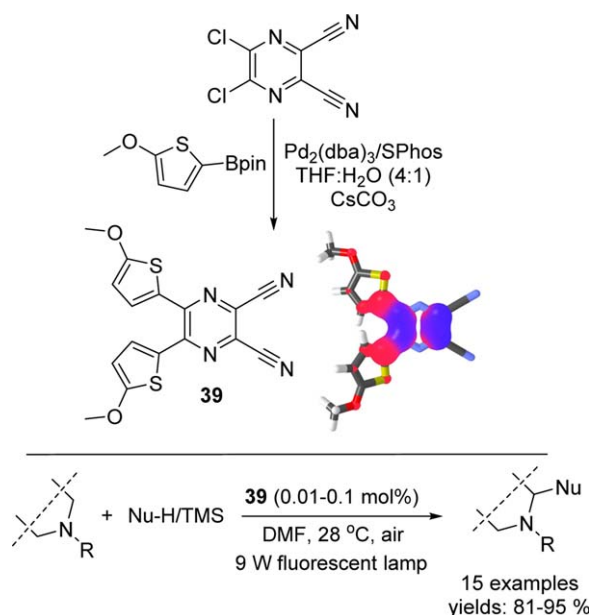

Fig. 14. DCB and DCP units in X-shaped CT chromophores.

branches interconnected by a central π -system. Typically, two branches bear electron acceptors and the other two are occupied by two donors in either parallel or antiparallel arrangements. The simplest central π -system is represented by a double bond. Diederich et al. have shown a new family of cyano-substituted chromophores **31–36** (Figure 13) called CEEs.^[60] Despite being simple in structure, these push-pull molecules based on former tetraethynylethenes (TEEs) proved to be tunable and very powerful electron acceptors, NLO-phores, solvatochromic probes, and materials for optoelectronic applications.^[61,2a] For instance, chromophore **31** turned out to form crystalline thin films for nanoscale data recording, while the most branched and extended derivative **36** showed one of the highest third-order polarizabilities $\gamma_{\text{rot}} = 45 \times 10^{-48} \text{ m}^5 \text{ V}^{-2}$ (degenerate four-wave mixing at 1500 nm, CH_2Cl_2).

Undoubtedly, 1,2,4,5-tetrasubstituted benzene is one of the most often employed central π -system in X-shaped molecules. The simplest X-shaped benzene (D- π)₂-B-(π -A)₂ cruciforms (B is benzene) were pioneered by Nalwa et al. in the early 1990s as NLOphores capable of forming Langmuir-Blodgett films.^[62] Since then, the design, synthesis, and applications of various benzene-derived X-shaped molecules can be considered as a burgeoning area. Their two-dimensional ICT, shape, arrangement, and thus, resulting peculiar (non)linear optical properties were also extensively investigated/predicted by quantum-chemical calculations.^[63] The pioneers of the modern era of X-shaped molecules are the groups of Marks,^[64] Buntz,^[65] and Haley.^[66] They developed a large number of cruciforms and have demonstrated their applicability as NLO-phores, fluorophores, ion-sensing molecules, and so forth.

Recently, we introduced benzene-1,2-dicarbonitrile (dicyanobenzene (DCB)) as an electron-withdrawing moiety suitable for the construction of X-shaped push-pull molecules **37** with two DMA donors linked at positions C4 and C5 (Figure 14).^[67] These chromophores were further compared with isolobal pyrazine derivatives **38** bearing a pyrazine-2,3-dicarbonitrile acceptor (dicyanopyrazine (DCP)).^[68] It was shown that heteroaromatic pyrazine acceptors imparted



Scheme 2. Synthesis, molecular structure, and HOMO (red)/LUMO (blue) localizations in photoredox catalyst **39** and its application in CDC reaction.

stronger ICT than aromatic benzene, as indicated by the narrowed HOMO–LUMO gap, bathochromically shifted longest-wavelength absorption maxima, and higher quinoid character. However, further property tuning has been carried out through a systematic extension of the π -system by various combinations of acetylenic and 1,4-phenylene units,^[69] which revealed that, especially for the most extended molecules ($n=2$), the optical nonlinearities of **37/38** were dictated not only by the electron-withdrawing power of the DCB and DCP units, but gradually also by the length, composition, and planarity of the π -system. Hence, the most extended chromophores **37** with the DCB unit showed higher second-harmonic generation (SHG) responses than isolobal DCP chromophores **38** (e.g., 3.2/3.0 or 4.9/3.1 pm V⁻¹).^[68]

Due to their optical and redox properties, selected dicyanopyrazines **38** were also envisaged as materials capable of undergoing photoinduced single electron transfer (SET). Upon modification of the electron-donating part with 5-methoxythienyl substituents and optimization of its synthesis, a very efficient photoredox catalyst **39** has been developed (Scheme 2).^[70] Its absorption maxima of 448 nm, band gap of 2.82 eV, and high ground-state dipole moment of 18.26 D proved to be well-balanced for the SET mechanism involved in the cross-dehydrogenative coupling (CDC) reaction. The high catalytic activity of **39** and scope of this reaction have been demonstrated on substituted tetrahydroisoquinolines and other amines and various nucleophiles (Scheme 2), as well as in photocatalytic oxidations, oxidative hydroxylations, and reductive dehalogenations. These reactions did not require

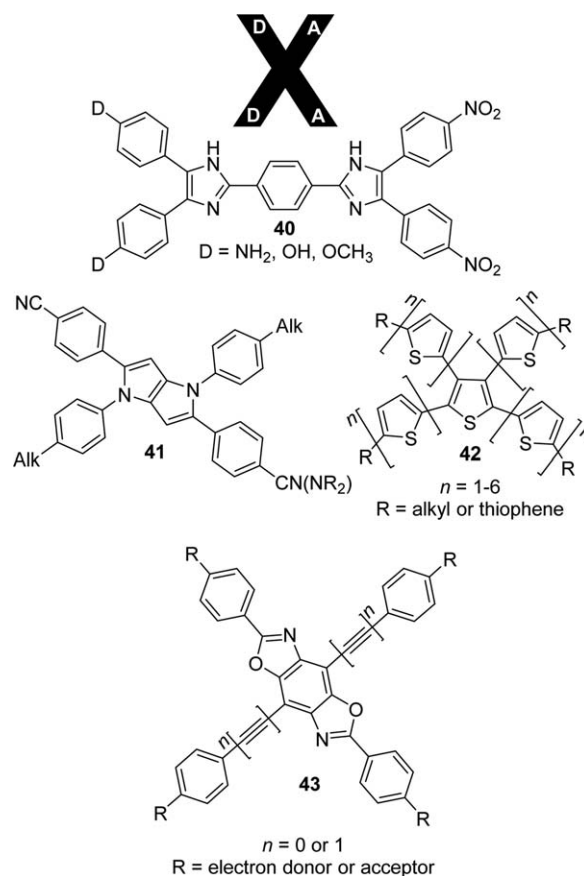

Fig. 15. Imidazole, pyrrolo[3,2-*b*]pyrrole, thiophene, and benzobisoxazole as a central π -cores for X-shaped molecules.

high-power light sources, long reaction times, air exclusion, or other special precautions, but provided the desired products in high yields, while the amount of **39** was less than 0.1 mol% and even 0.01%, which represents the lowest catalyst loading in current photoredox organocatalysis. Moreover, the high catalytic performance of **39** and utilization of itaconimide as a nucleophile in the CDC allowed the chemoselective control of radical cascade reactions (addition–cyclization, addition–elimination, addition–coupling, and addition–protonation), providing direct access to four new types of tetrahydroisoquinoline derivatives.^[71]

DCP-derived molecules similar to **38** incorporated into a polymeric backbone were also investigated as thermally stable multi-ICT chromophores by Ye et al.^[72] In addition to parent six-membered (hetero)aromatics, X-shaped chromophores can also be built on five-membered heterocycles, such as imidazole (**40**) or fused pyrrolo[3,2-*b*]pyrroles (**41**; Figure 15). Two reversely disubstituted imidazoles linked by 1,4-phenylene moiety in **40** adopted the X shape and were successfully applied as NLOphores upon incorporation into a polymer (PI or PMMA), achieving good nonlinearity–transparency–

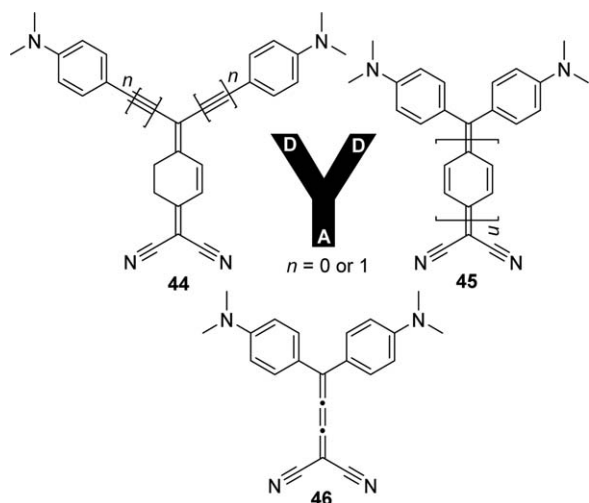

Fig. 16. Quinoid and cumulenonic chromophores 44–46.

thermal stability trade-off.^[73] Very recently, Gryko et al. showed a modular synthetic approach towards tetraarylpyrrolo[3,2-*b*]pyrroles (41, TAPPs) with four π -branches bearing a CN acceptor or eventually an amino donor.^[74] These new π -conjugated materials showed appreciable fluorescent and two-photon absorbing properties. Tetrasubstituted thiophenes, especially those with an oligomeric structure, such as 42, proved to be electroactive materials with perspective applications in organic solar cells.^[75]

The central π -system of X-shaped molecules can be further extended to fused (hetero)aromatic compounds, such as benzobisoxazoles, to form typical cruciforms 43. These molecules, mostly investigated by Nuckolls et al.^[76] and Miljanić et al.,^[77] were applied in molecular electronics or as fluorophores/fluorescent sensors.

To finish the series of X-shaped molecules, we have to mention that the X arrangement can also be achieved using fused aromatic compounds, such as naphthalene,^[78] anthracene,^[79] pyrene,^[80] or even more extended π -cores.^[81] The modern applications of these larger systems profit mainly from their large emissive and semiconducting character, and therefore, range from fluorophores, 2PAs, and OLEDs to OFETs.

7. Y-Shaped Molecules

Similarly to X-shaped molecules, Y-shaped push–pull chromophores constitute a large family of molecules, which can be constructed on a variety of π -scaffolds. Due to their shape and arrangement, they are often referred to as tripodal or octupolar. Nevertheless, in this section, we focus on selected Y-shaped molecules with the π -system built on multiple bonds, five-membered heterocycles, triphenylamine (TPA), azines, and some other related central moieties. The Y-shaped systems

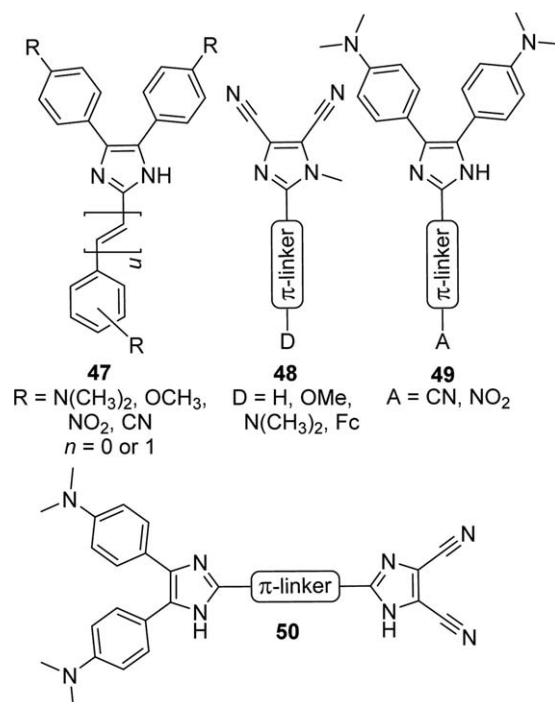
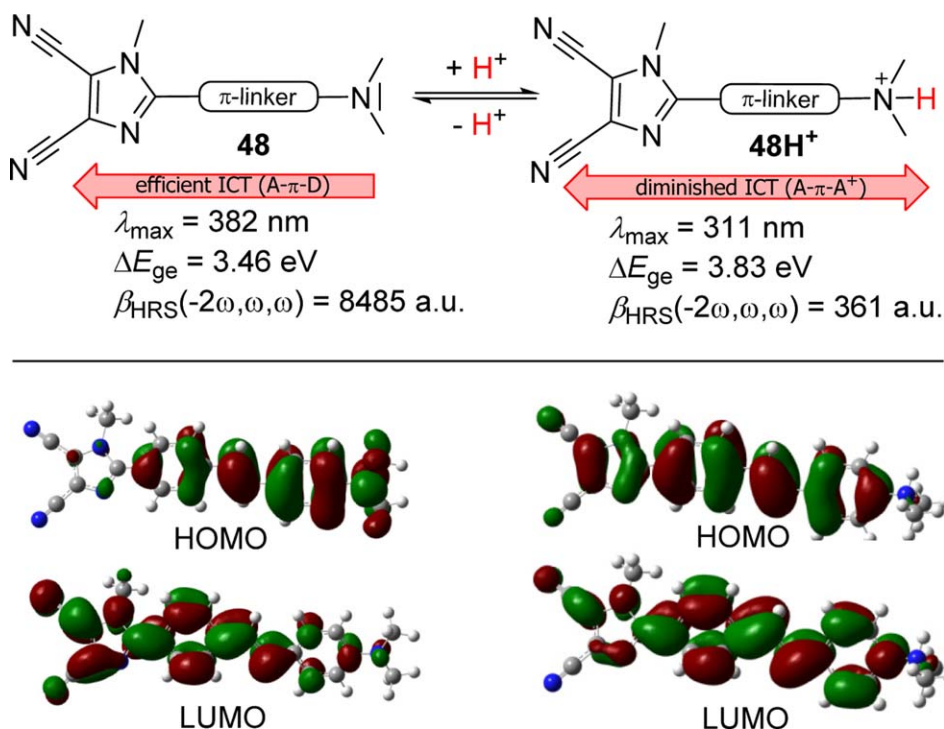

Fig. 17. Imidazole-derived Y-shaped push–pull chromophores 47–50 with various arrangements of electron acceptors and donors around the imidazole central core.

based on a combination of multiple bonds are frequently related to V(X)-shaped molecules. For instance, semi- or expanded quinoids 44 and 45;^[82] buta-1,2,3-triene 46 (Figure 16);^[83] and donor–acceptor 4*H*-pyran-4-ylidene derivatives, such as 22 (Figure 10),^[39e-g,42b] were investigated as proaromatic and proacetylenic chromophores with exceptionally small HOMO–LUMO gaps, as well as nonracemic NLOphores and fluorophores.

In addition to unsaturated hydrocarbon π -backbones in 44 and 45, we started our research on Y shapes with heteroaromatic 1*H*-imidazole.^[6] The first series of push–pull molecules 47 (Figure 17) was built on simple lophine (2,4,5-triphenylimidazole).^[84] Subsequently, we focused on imidazole-4,5-dicarbonitrile (dicyanoimidazole (DCI)) as a five-membered electron acceptor related to DCP. Despite its lower electron-withdrawing ability than DCP, DCI-derived molecules 48 were easy to synthesize and turned out to be suitable model push–pull chromophores for fundamental structure–property relationships studies.^[85] Both extension and branching of the π -system, as well as variation of the electron donor D, were thoroughly and systematically evaluated.^[1]

Chromophores 49 represent the opposite arrangement of electron donors around the central imidazole core to that in 48.^[86] In 49, positions C4 and C5 are occupied by DMA electron donors, whereas the acceptor is placed at C2 separated by



Scheme 3. The pH-triggered NLO switching of *N,N*-dimethylamino-substituted DCI chromophores **48** (π -linker = stilbenyl).

an additional linker. It turned out that 1*H*-imidazole was more polarizable with ICT transmitting from C4/C5 to C2 rather than vice versa. Hence, our further synthetic efforts were directed towards a combination of both imidazole moieties to afford bisimidazoles **50** bearing electron-releasing 4,5-bis[4-(*N,N*-dimethylamino)phenyl]imidazole and the DCI acceptor.^[87] Optoelectronic properties of imidazole derivatives **47–50** were further studied by electrochemistry, absorption/emission spectra, and SHG experiments completed by DFT calculations.^[88] Whereas the DCI chromophores **48** bearing *N,N*-dimethylamino donor D were used as pH-triggered NLO switches (Scheme 3),^[89] push–pull systems **48** bearing a double bond (styrene and stilbene π -linkers) underwent reversible E→Z photoisomerization.^[90] As can be seen in Scheme 3, simple protonation taking place exclusively on the amino donor can diminish the ICT in **48**, which is reflected by the hypsochromically shifted absorption maxima ($\Delta\lambda_{\text{max}} = 71 \text{ nm}$), high contrast of the NLO response between **48** and **48H⁺** (23.5), and increased differences between the HOMO and LUMO (ΔE_{ge}) and their distributions along the π -system (no charge separation upon protonation).

On the contrary, imidazole chromophores **49** with two DMA units showed significant light emission as a response to applied electric field, and therefore, were used as promising active materials for OLEDs.^[91]

Since the pioneering work of Moylan et al.,^[92] imidazole^[93] and thiazole^[94] become standard five-membered heterocyclic moieties widely used for the construction of Y-shaped chromophores, which were mainly utilized as robust NLO-phores, fluorophores, chemosensors, and emissive materials. Thiazole proved to be more polarizable than oxazole or imidazole, and therefore, fused thiazole and related derivatives are considerably investigated as novel central π -conjugated scaffolds for Y-shaped molecules.^[95]

TPA is another scaffold and central electron donor widely employed in the construction of centrifugal Y-shaped molecules. Tripodal push–pull TPA derivatives are increasingly popular as 2PAs, semiconducting materials, fluorophores, biosensors, and dyes for DSSCs.^[96] Despite recent progress made in understanding the 2PA process in organic push–pull systems,^[13] chromophores **51** (Figure 18) with variable peripheral cyano acceptor groups and moieties were designed as model tripodal push–pull molecules to systematically elucidate structure–2PA property relationships for TPA derivatives.^[97] Electron-withdrawing behavior, structure, number of CN groups, and their mutual orientation within the acceptor moiety, as well as extension and composition of the π -bridge have influenced the 2PA properties of **51** most significantly. In a subsequent paper, we also systematically studied branching and solvent effects on the 2PA activity of selected derivatives

51 (according to the number of R substituents).^[98] It turned out that, when going from linear to quadrupolar systems, the 2PA activity increased most significantly, whereas a change

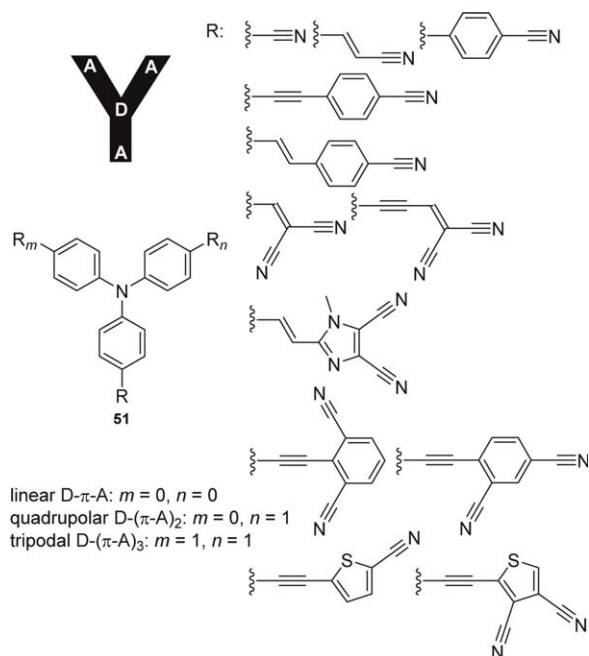

Fig. 18. TPA derivatives **51** with systematically altered peripheral (poly)cyano-substituted acceptor moieties.

from quadrupolar to tripodal arrangements had a diminished effect. However, both effects are more or less pronounced, depending on the solvent used.

The TPA core can also be conveniently equipped with heteroaromatic diazine acceptor units (pyrimidine, pyrazine,

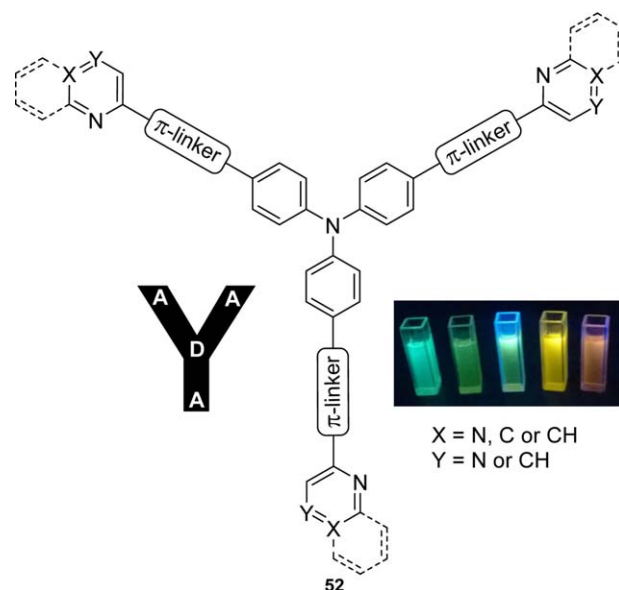
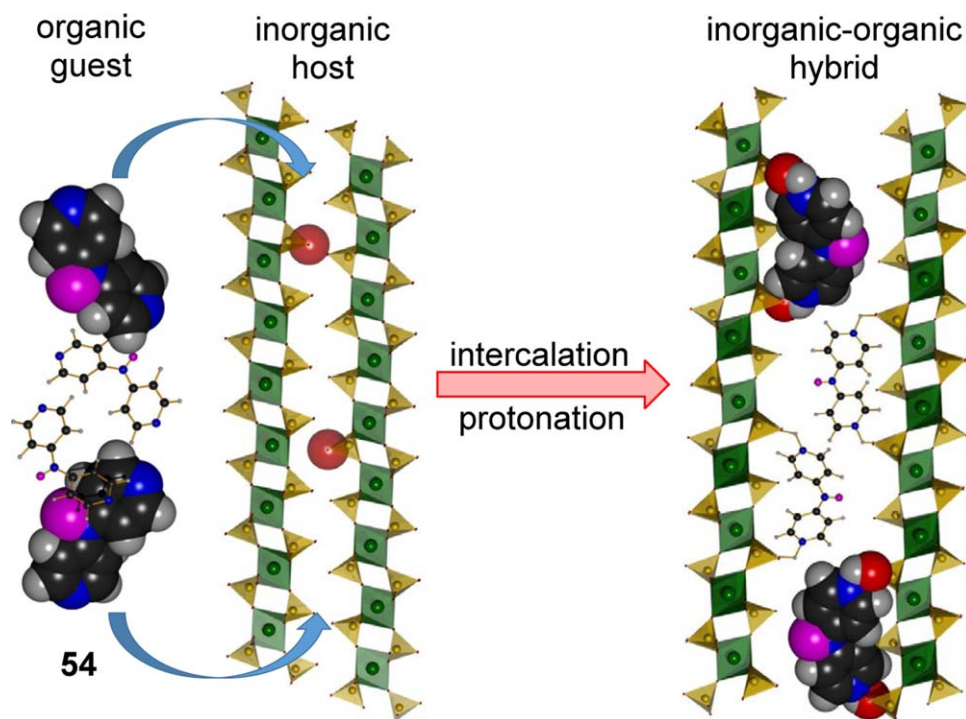

Fig. 19. Tripodal derivatives bearing peripheral diazine acceptors and their solvatochromism.



Scheme 4. Schematic representation of the intercalation process of **54** into layered inorganic hosts.

and quinoxaline) as in 2PAs **52** (Figure 19) with strong emission solvatochromism.^[99]

Based on a successful approach of improving the electron-withdrawing ability of pyridine acceptors through protonation/quaternization (see above), we have envisaged that pyridine-terminated TPA derivatives represent an ideal model of chromophores bearing peripheral basic centers,

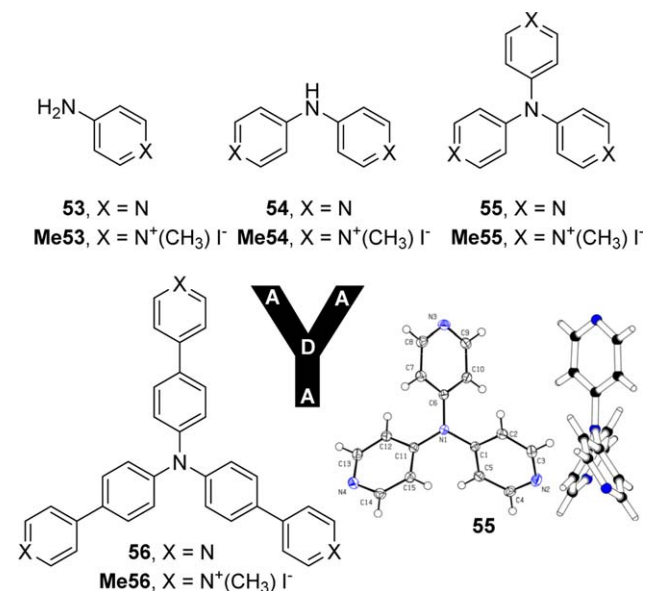

Fig. 20. Molecular structures and X-ray analysis of aminopyridine and TPA derivatives **53–56** with various spatial arrangements.

allowing their intercalation into acid layered materials (Scheme 4).^[52,100]

Starting from linear 4-aminopyridine **53**, we have prepared quadrupolar di- and tripodal tripyridylamines **54** and **55**, extended TPA derivative **56**, and their N-methyl analogues (**Me**; Figure 20). Despite being simple in the structure, tripyridylamine **55** has been prepared for the first time; X-ray analysis showed an almost perfectly symmetrical structure. The extent and character of the intercalation process of **53–55** (Scheme 4) into alpha modification of zirconium hydrogen phosphate (**ZrP**), zirconium 4-sulfophenylphosphonate (**ZrSPP**), and gamma modification of titanium hydrogen phosphate (**TiP**) were studied by various methods. The following features should be stressed herein: 1) the ratio of the amount of intercalated **53–55** was 6:3:2, which was inversely proportional to the charge generated at each aminopyridine guest (1:2:3); 2) **53–55** underwent (partial) protonation during intercalation, depending on the number of basic centers and acidity of the host; 3) improved thermal and chemical resistance of the organic guest upon encapsulation into inorganic host; 4) protonation improved the ICT, redshifted the λ_{\max} , and reduced the ΔE ; and 5) supramolecular organization of **53–55** in the layered materials further enhanced their SHG responses (compare the data shown in Table 2 for **53–55**, **Me53–Me55**, and their intercalates). Thus, intercalation is a very useful strategy to achieve inorganic–organic hybrid materials with tailored (NLO) properties.

A replacement of the central nitrogen atom in TPA by phosphorus or boron leads to phosphane oxide- or borane-

Table 2. Properties and optical nonlinearities of **53–55**, **Me53–Me55**, and their intercalates.

Comp.	λ_{\max} [nm (eV)] ^[a]	ΔE [eV] ^[b]	μ [D] ^[b]	$\beta(-2\omega; \omega, \omega)$ [10 ⁻³⁰ esu] ^[c]	d_{eff} [pm/V] ^[d]
53	248 (5.00)	5.86	5.36	1.06	1.34
54	293 (4.23)	4.95	3.64	1.44	1.56
55	307 (4.04)	4.72	0.02	0.01	0.35
Me53	271 (4.58)	5.40	0.58	1.37	1.42
Me54	326 (3.80) ^[e]	4.54	0.16	2.61	1.67
Me55	323 (3.84) ^[e]	4.41	0.06	0.13	1.04
ZrSPP-53	263 (4.71)	–	–	–	1.78
ZrSPP-54	317 (3.91)	–	–	–	1.89
ZrSPP-55	323 (3.84)	–	–	–	1.21
ZrP-53	260 (4.77)	–	–	–	1.67
ZrP-54	297 (4.18)	–	–	–	1.72
ZrP-55	305 (4.06)	–	–	–	1.45
TiP-53	261 (4.75)	–	–	–	2.01
TiP-54	305 (4.07)	–	–	–	2.21
TiP-55	315 (3.94)	–	–	–	1.56

[a] Measured in the solid state (Al₂O₃). [b] DFT calculations (at the B3LYP/6-311++G(2d,p)//B3LYP/6-311++G(2d,p) level) in DMF. [c] DFT calculations (at the B3LYP/6-311++G(2d,p)//B3LYP/6-311++G(2d,p) level) in vacuum at 1064 nm. [d] Measured in oligoetheracrylate at 1064 nm (± 0.15 pm/V). [e] Shoulder at 392 (3.16) nm (eV).

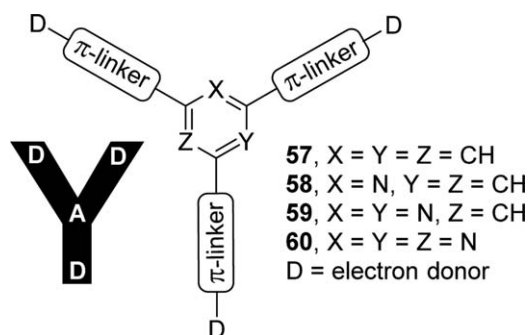

Fig. 21. Centripetal Y-shaped molecules **57–60** based on various (hetero)aromatic moieties.

derived tripodal push–pull molecules with noticeable NLO activity.^[101] However, these molecules are complicated to prepare and generally suffer from lower stability than TPA.

The centrifugal arrangement of TPA derivatives can be reversed to centripetal if electron-deficient cores, such as 1,3,5-trisubstituted benzene **57**,^[102] 2,4,6-trisubstituted pyridine **58**,^[103] and pyrimidine **59**,^[104] are employed (Figure 21). However, the most widely employed central electron acceptor for star-shaped centripetal push–pull molecules is undoubtedly triazine **60**.^[105] Increasing the number of heteroatoms within the central ring imparts stronger ICT into the branches, and therefore, chromophores **57–60** are increasingly polarized. The applications range from second-order NLOs, 2PAs, liquid crystals, photovoltaics, and OLEDs to molecules showing aggregation-induced emission.

8. Conclusion

We have attempted to demonstrate herein that the recent design of organic push–pull molecules can be inspired by letters of the alphabet. This article intends to show how heterogeneously organic chemists can trifle with known patterns to combine them into novel types of π -conjugated molecules with the properties tailored to satisfy numerous requests of materials chemists. Various extraordinary arrangements, in particular H-, L-, T-, V-, X-, and Y-shapes, can be revealed in the current literature. We focused our research activity especially towards T-, X-, and Y-shaped molecules, which were discussed in more detail. The parent π -conjugated moieties utilized for the construction of these letter-shaped D- π -A chromophores involve (hetero)aromatic compounds such as indan-1,3-dione, olefinic and acetylenic scaffolds, benzene, pyrazine, imidazole, pyridine, and TPA. These units are most often equipped with peripheral acceptors, donors, and eventually an additional π -linker, but the electron-releasing or -withdrawing moieties can also be incorporated directly into the

chromophore π -backbone. In our opinion, the most fascinating feature of push–pull molecules is their tunable properties. Hence, organic CT chromophores can be directed towards second-order NLOs, two-photon absorption, NLO switches, fluorophores, OLEDs, OFETs, DSSCs, photocatalysis, intercalation, and so forth. The current push–pull molecules can surely be considered as old friends with a new look and applications. In the near future, we eagerly expect novel letter-shaped push–pull molecules to gradually fill the whole alphabet.

Acknowledgements

This work has received funding from the European Research Council (ERC) under the European Union's Horizon 2020 research and innovation program (grant agreement no. [638857]). We would like to express our sincere thanks to our colleagues and collaborators for their outstanding support, contribution, and enthusiasm. Without their generous support, this multidisciplinary research would not be possible (O. Pytela, J. Kulhánek, M. Ludwig, J. Macák, T. Mikysek, N. Almonasy, V. Zima, M. Danko, A. Růžicka, Z. Růžicková, F. Diederich, M. Kivala, I. Kityk, W. Kuznik, S. Achelle, A. Barsella, B. Champagne, M. Fakis, Z. Jiang).

REFERENCES

- [1] F. Bureš, *RSC Adv.* **2014**, *4*, 58826–58851.
- [2] a) P. D. Jarowski, Y. Mo, *Chem. Eur. J.* **2014**, *20*, 17214–17221; b) M. Kivala, F. Diederich, *Acc. Chem. Res.* **2009**, *42*, 235–248; c) J. Roncali, *Macromol. Rapid. Commun.* **2007**, *28*, 1761–1775; d) H. Meier, *Angew. Chem. Int. Ed.* **2005**, *44*, 2482–2506; e) H. A. M. van Mellekom, J. A. J. M. Vekemans, E. E. Havinga, E. W. Meijer, *Mater. Sci. Eng.* **2001**, *32*, 1–40; f) J. Roncali, *Chem. Rev.* **1997**, *97*, 173–205.
- [3] a) S. Achelle, N. Plé, A. Turck, *RSC Adv.* **2011**, *1*, 364–388; b) S. Achelle, N. Plé, *Curr. Org. Synth.* **2012**, *9*, 163–187; c) A. Wild, A. Winter, F. Schlütter, U. S. Schubert, *Chem. Soc. Rev.* **2011**, *40*, 1459–1511.
- [4] a) V. Malyskiy, J.-J. Simon, L. Patrone, J.-M. Raimundo, *RSC Adv.* **2015**, *5*, 354–397; b) K. Takimiya, I. Osaka, *Chem. Rec.* **2015**, *15*, 175–188.
- [5] *Handbook of Thiophene-Based Materials, Applications in Organic Electronics and Photonics*, Vols. 1 and 2 (Eds.: I. F. Perepichka, D. F. Perepichka), Wiley, Chichester, **2009**.
- [6] a) J. Kulhánek, F. Bureš, *Beilstein J. Org. Chem.* **2012**, *8*, 25–49; b) F. Bureš, *Chem. Listy* **2013**, *107*, 834–842.
- [7] K. Hübner, *Chem. Unserer Zeit* **2006**, *40*, 274–275.
- [8] a) P. N. Prasad, D. J. Williams, *Introduction to Nonlinear Optical Effects in Molecules & Polymers*, Wiley, New York, **1991**; b) K. Y. Suponitsky, T. V. Timofeeva, M. Y. Antipin, *Russ. Chem. Rev.* **2006**, *75*, 457–496.

- [9] a) Special issue on Organic Electronics and Optoelectronics (Eds.: S. R. Forrest, M. E. Thompson): *Chem. Rev.* **2007**, *107*, 923–1386; b) special issue on *Materials for Electronics* (Eds.: R. D. Miller, E. A. Chandross): *Chem. Rev.* **2010**, *110*, 1–574; c) special issue on *Molecular Electronics—From a Visionary Concept towards Reality* (Ed.: M. Mayor): *Chimia* **2010**, *64*, 348–420.
- [10] a) Y. Wu, W. Zhu, *Chem. Soc. Rev.* **2013**, *42*, 2039–2058; b) M. Liang, J. Chen, *Chem. Soc. Rev.* **2013**, *42*, 3453–3488; c) J. N. Clifford, E. Martínez-Ferrero, A. Viterisi, E. Palomares, *Chem. Soc. Rev.* **2011**, *40*, 1635–1646.
- [11] a) A. Mishra, P. Bäuerle, *Angew. Chem. Int. Ed.* **2012**, *51*, 2020–2067; b) C. Duan, F. Huang, Y. Cao, *J. Mater. Chem. C* **2012**, *22*, 10416–10434; c) B. Walker, C. Kim, T.-Q. Nguyen, *Chem. Mater.* **2011**, *23*, 470–482.
- [12] Y. Ohmori, *Laser Photonics Rev.* **2009**, *4*, 300–310.
- [13] a) M. Pawlicki, H. A. Collins, R. G. Denning, H. L. Anderson, *Angew. Chem. Int. Ed.* **2009**, *48*, 3244–3266; b) G. S. He, L.-S. Tan, Q. Zheng, P. N. Prasad, *Chem. Rev.* **2008**, *108*, 1245–1330.
- [14] G. Qian, Z. Y. Wang, *Chem. Asian J.* **2010**, *5*, 1006–1029.
- [15] a) C.-Z. Zhang, C. Lu, J. Zhu, G.-Y. Lu, X. Wang, Z.-W. Shi, F. Liu, Y. Cui, *Chem. Mater.* **2006**, *18*, 6091–6093; b) C.-Z. Zhang, C. Lu, J. Zhu, C.-Y. Wang, G.-Y. Lu, C.-S. Wang, D.-L. Wu, F. Liu, Y. Cui, *Chem. Mater.* **2008**, *20*, 4628–4641; c) C.-Z. Zhang, J. Zhu, C. Lu, G.-Y. Lu, Y. Cui, *Mater. Chem. Phys.* **2009**, *114*, 515–517; d) C. Z. Zhang, G. Y. Lu, C. S. Wang, *Chin. Chem. Lett.* **2009**, *20*, 620–622; e) J. Zhu, C. Lu, Y. Cui, C. Zhang, G. Lu, *J. Chem. Phys.* **2010**, *133*, 244503; f) Z. Liu, G.-Y. Lu, J. Ma, *J. Phys. Org. Chem.* **2011**, *24*, 568–577.
- [16] J.-P. Shi, D.-L. Wu, Y. Ding, D.-H. Wu, H.-W. Hu, G.-Y. Lu, *Tetrahedron* **2012**, *68*, 2770–2777.
- [17] S. Cong, A. Zhang, F. Liu, D. Yang, M. Zhang, S. Bo, X. Liu, L. Qiu, Z. Zhen, *RSC Adv.* **2015**, *5*, 10497–10504.
- [18] a) W. Wu, C. Ye, J. Qin, Z. Li, *ChemPlusChem* **2013**, *78*, 1523–1529; b) Z. Li, G. Qiu, C. Ye, J. Qin, Z. Li, *Dyes Pigment.* **2012**, *94*, 16–22; c) Z. Li, W. Wu, G. Yu, Y. Liu, C. Ye, J. Qin, Z. Li, *ACS Appl. Mater. Interfaces* **2009**, *1*, 856–863; d) Z. Li, Z. Li, C. Di, Z. Zhu, Q. Li, Q. Zeng, K. Zhang, Y. Liu, C. Ye, J. Qin, *Macromolecules* **2006**, *39*, 6951–6961.
- [19] Y. Zhang, T. Han, S. Gu, T. Zhou, C. Zhao, Y. Guo, X. Feng, B. Tong, J. Bing, J. Shi, J. Zhi, Y. Dong, *Chem. Eur. J.* **2014**, *20*, 8856–8861.
- [20] H. Akdas-Kilig, T. Roisnel, I. Ledoux, H. Le Bozec, *New J. Chem.* **2009**, *33*, 1470–1473.
- [21] Y. Liu, F. Zhang, C. He, D. Wu, X. Zhuang, M. Xue, Y. Liu, X. Feng, *Chem. Commun.* **2012**, *48*, 4166–4168.
- [22] X.-X. Wang, T. Tao, J. Geng, B.-B. Ma, Y.-X. Peng, W. Huang, *Chem. Asian J.* **2014**, *9*, 514–525.
- [23] X. Zhao, K. Cao, H. Zhou, R. Lu, *Opt. Mater.* **2014**, *36*, 950–957.
- [24] R. C. Lirag, H. T. M. Le, O. Š. Miljanić, *Chem. Commun.* **2013**, *49*, 4304–4306.
- [25] R. Centore, S. Fusco, A. Peluso, A. Capobianco, M. Stolte, G. Archetti, H.-G. Kuball, *Eur. J. Org. Chem.* **2009**, 3535–3543.
- [26] P. Solanke, F. Bureš, O. Pytela, J. Kulhánek, Z. Padělková, *Synthesis* **2013**, *45*, 3044–3051.
- [27] P. Solanke, F. Bureš, O. Pytela, M. Klikar, T. Mikysek, L. Mager, A. Barsella, Z. Růžicková, *Eur. J. Org. Chem.* **2015**, *24*, 5339–5349.
- [28] A. Felouat, A. D’Aleó, A. Charaf-Eddin, D. Jacquemin, B. Le Guennic, E. Kim, K. J. Lee, J. Heun, Woo, J.-C. Ribierre, J. W. Wu, F. Fages, *J. Phys. Chem. A* **2015**, *119*, 6283–6295.
- [29] N. Zhigang, L. Dachao, L. Dong, X. Dong, Z. Ying, S. Wei, L. Gaonan, *Chem. Res. Chin. Univ.* **2014**, *30*, 425–430.
- [30] J. Geng, Y. Dai, X.-X. Wang, M.-Y. Hu, T. Tao, W. Huang, *Tetrahedron* **2015**, *71*, 654–662.
- [31] Z.-H. Guo, T. Lei, Z.-X. Jin, J.-Y. Wang, J. Pei, *Org. Lett.* **2013**, *15*, 3530–3533.
- [32] X. Lu, S. Fan, J. Wu, X. Jia, Z.-S. Wang, G. Zhou, *J. Org. Chem.* **2014**, *79*, 6480–6489.
- [33] L. V. Brownell, K. A. Robins, Y. Jeong, Y. Lee, D.-C. Lee, *J. Phys. Chem. C* **2013**, *117*, 25236–25247.
- [34] a) D.-C. Lee, K. Jang, K. K. McGrath, R. Uy, K. A. Robins, D. W. Hatchett, *Chem. Mater.* **2008**, *20*, 3688–3695; b) K. Jang, J. M. Kinyanjui, D. W. Hatchett, D.-C. Lee, *Chem. Mater.* **2009**, *21*, 2070–2076; c) K. Jang, A. D. Ranasinghe, C. Heske, D.-C. Lee, *Langmuir* **2010**, *26*, 13630–13636.
- [35] a) T. Inouchi, T. Nakashima, M. Toba, T. Kawai, *Chem. Asian J.* **2011**, *6*, 3020–3027; b) T. Inouchi, T. Nakashima, T. Kawai, *Asian J. Org. Chem.* **2013**, *2*, 230–238; c) T. Inouchi, T. Nakashima, T. Kawai, *J. Phys. Chem. A* **2014**, *118*, 2591–2598.
- [36] N. Noujeim, K. Zhu, V. N. Vukotic, S. J. Loeb, *Org. Lett.* **2012**, *14*, 2484–2487.
- [37] a) A. C. Benniston, A. Harriman, S. L. Howell, P. Li, D. P. Lydon, *J. Org. Chem.* **2007**, *72*, 888–897; b) D. P. Lydon, P. Li, A. C. Benniston, W. McFarlane, R. W. Harrington, W. Clegg, *Eur. J. Org. Chem.* **2007**, 1653–1658.
- [38] a) K.-S. Moon, H.-J. Kim, E. Lee, M. Lee, *Angew. Chem. Int. Ed.* **2007**, *46*, 6807–6810; b) L. Liu, K.-S. Moon, R. Gunawidjaja, E. Lee, V. V. Tsukruk, M. Lee, *Langmuir* **2008**, *24*, 3930–3936.
- [39] a) C. R. Moylan, S. Ermer, S. M. Lovejoy, I.-H. McComb, D. S. Leung, R. Wortmann, P. Krdmer, R. J. Twieg, *J. Am. Chem. Soc.* **1996**, *118*, 12950–12955; b) C. Sissa, F. Terenziani, A. Painelli, R. B. Kanth Siram, S. Patil, *J. Phys. Chem. B* **2012**, *116*, 4959–4966; c) G. Koeckelberghs, L. De Groof, J. Pérez-Moreno, I. Asselberghs, K. Clays, T. Verbiest, C. Samyn, *Tetrahedron* **2008**, *64*, 3772–3781; d) R. Andreu, L. Carrasquer, J. Garín, M. J. Modrego, J. Orduna, R. Alicante, B. Villacampa, M. Allain, *Tetrahedron Lett.* **2009**, *50*, 2920–2924; e) R. Andreu, E. Galán, J. Garín, V. Herrero, E. Lacarra, J. Orduna, R. Alicante, B. Villacampa, *J. Org. Chem.* **2010**, *75*, 1684–1692; f) S.-S. P. Chou, C.-Y. Yu, *Synth. Met.* **2004**, *142*, 259–262; g) E. Gubbelmans, T. Verbiest, I. Picard, A. Persoons, C. Samyn, *Polymer* **2005**, *46*, 1784–1795.

- [40] J. Kulhánek, F. Bureš, J. Opršal, W. Kuznik, T. Mikysek, A. Růžička, *Asian J. Org. Chem.* **2013**, *2*, 422–431.
- [41] D. Jana, B. K. Ghorai, *Tetrahedron* **2012**, *68*, 7309–7316.
- [42] a) S. Achelle, I. Nouira, B. Pfaffinger, Y. Ramondenc, N. Plé, J. Rodríguez-López, *J. Org. Chem.* **2009**, *74*, 3711–3717; b) S. Achelle, S. Kahlal, J.-Y. Saillard, N. Cabon, B. Caro, F. Robin-le Guen, *Tetrahedron* **2014**, *70*, 2804–2815; c) S. Achelle, J. R. Lopez, F. Bureš, F. Robin-le Guen, *Dyes Pigm.* **2015**, *121*, 305–311; d) S. Achelle, J. P. Malval, S. Aloise, A. Barsella, A. Spangenberg, L. Mager, H. Akdas-Kilig, J. L. Fillaut, B. Caro, F. Robin-le Guen, *ChemPhysChem* **2013**, *14*, 2725–2738.
- [43] J.-P. Malval, S. Achelle, L. Bodiou, A. Spangenberg, L. C. Gomez, O. Soppera, F. Robin-le Guen, *J. Mater. Chem. C* **2014**, *2*, 7869–7880.
- [44] S. Achelle, J. Rodríguez-López, N. Cabon, F. Robin-le Guen, *RSC Adv.* **2015**, *5*, 107396–107399.
- [45] L. Skardziute, J. Dodonova, A. Voitechoviccius, J. Jovaisaite, R. Komskis, A. Voitechovicziute, J. Bucevicius, K. Kazlauskas, S. Jursenas, S. Tumkevicius, *Dyes Pigm.* **2015**, *118*, 118–128.
- [46] a) J. Dhuguru, C. Gheewala, N. S. Saleesh Kumar, J. N. Wilson, *Org. Lett.* **2011**, *13*, 4188–4191; b) E. Adjaye-Mensah, W. G. Gonzalez, D. R. Bussé, B. Captain, J. Miksovskaja, J. N. Wilson, *J. Phys. Chem. A* **2012**, *116*, 8671–8677.
- [47] a) S. Achelle, J. Rodríguez-López, F. Robin-le Guen, *J. Org. Chem.* **2014**, *79*, 7564–7571; b) J.-H. Huang, W.-H. Wen, Y.-Y. Sun, P.-T. Chou, J.-M. Fang, *J. Org. Chem.* **2005**, *70*, 5827–5832; c) F. Todescato, I. Fortunati, S. Carlotto, C. Ferrante, L. Grisanti, C. Sissa, A. Painelli, A. Colombo, C. Dragonetti, D. Roberto, *Phys. Chem. Chem. Phys.* **2011**, *13*, 11099–11109; d) R. Juárez, M. Ramos, J. L. Segura, J. Orduna, B. Villacampa, R. Alicante, *J. Org. Chem.* **2010**, *75*, 7542–7549.
- [48] a) M. A. Ramirez, A. M. Cuadro, J. Alvarez-Builla, O. Castano, J. L. Andrés, F. Mendicuti, K. Clays, I. Asselbergh, J. J. Vaquero, *Org. Biomol. Chem.* **2012**, *10*, 1659–1669; b) M. A. Ramirez, T. Caneque, A. M. Cuadro, F. Mendicuti, K. Clays, I. Asselbergh, J. J. Vaquero, *ARKIVOC* **2011**, *iii*, 140–155.
- [49] E. Maçôas, G. Marcelo, S. Pinto, T. Caneque, A. M. Cuadro, J. J. Vaquero, J. M. G. Martinho, *Chem. Commun.* **2011**, *47*, 7374–7376.
- [50] B. J. Coe, J. Fielden, S. P. Foxon, J. A. Harris, M. Helliwell, B. S. Brunshwig, I. Asselberghs, K. Clays, J. Garín, J. Orduna, *J. Am. Chem. Soc.* **2010**, *132*, 10498–10512.
- [51] M. Tasiar, V. Hugues, M. Blanchard-Desce, D. T. Gryko, *Asian J. Org. Chem.* **2013**, *2*, 669–673.
- [52] F. Bureš, D. Cvejn, K. Melánová, L. Beneš, J. Svoboda, V. Zima, O. Pytela, T. Mikysek, Z. Růžičková, I. V. Kityk, A. Wojciechowski, N. AlZayed, *J. Mater. Chem. C* **2016**, *4*, 468–478.
- [53] a) W.-J. Kuo, G.-H. Hsiue, R.-J. Jeng, *Macromol. Rapid Commun.* **2001**, *22*, 601–606; b) W.-J. Kuo, G.-H. Hsiue, R.-J. Jeng, *J. Mater. Chem.* **2002**, *12*, 868–878; c) H.-C. Tsai, W.-J. Kuo, G.-H. Hsiue, *Macromol. Rapid Commun.* **2005**, *26*, 986–991.
- [54] J.-F. Xing, W.-Q. Chen, J. Gu, X.-Z. Dong, N. Takeyasu, T. Tanaka, X.-M. Duan, S. Kawata, *J. Mater. Chem.* **2007**, *17*, 1433–1438.
- [55] a) S. Ramkumar, S. Manoharan, S. Anandan, *Dyes Pigm.* **2012**, *94*, 503–511; b) J. He, J. Hua, G. Hu, X. J. Yin, H. Gong, C. Li., *Dyes Pigm.* **2014**, *104*, 75–82.
- [56] Y. Wei, X. Zhang, L. Wang, Y. Liu, T. Bing, X. Liu, D. Shangguan, *RSC Adv.* **2015**, *5*, 75911–75917.
- [57] G. S. Kumar, K. Srinivas, B. Shanigaram, D. Bharath, S. P. Singh, K. Bhanuprakash, V. J. Rao, A. Islam, *RSC Adv.* **2014**, *4*, 13172–13181.
- [58] a) M. Lehmann, C. Köhn, H. Kresse, Z. Vakhovskaya, *Chem. Commun.* **2008**, 1768–1770; b) M. Lehmann, J. Seltmann, A. A. Auer, E. Prochnow, U. Benedikt, *J. Mater. Chem.* **2009**, *19*, 1978–1988; c) J. Seltmann, A. Marini, B. Mennucci, S. Dey, S. Kumar, M. Lehmann, *Chem. Mater.* **2011**, *23*, 2630–2636.
- [59] X. Mei, G. Wen, J. Wang, H. Yao, Y. Zhao, Z. Lin, Q. Ling, *J. Mater. Chem. C* **2015**, *3*, 7267–7271.
- [60] a) N. N. P. Moonen, C. Boudon, J.-P. Gisselbrecht, P. Seiler, M. Gross, F. Diederich, *Angew. Chem. Int. Ed.* **2002**, *41*, 3044–3047; b) N. N. P. Moonen, R. Gist, C. Boudon, J.-P. Gisselbrecht, P. Seiler, T. Kawai, A. Kishioka, M. Gross, M. Irie, F. Diederich, *Org. Biomol. Chem.* **2003**, *1*, 2032–2034; c) N. N. P. Moonen, W. C. Pomerantz, R. Gist, C. Boudon, J.-P. Gisselbrecht, T. Kawai, A. Kishioka, M. Gross, M. Irie, F. Diederich, *Chem. Eur. J.* **2005**, *11*, 3325–3341; d) F. Bureš, W. B. Schweizer, J. C. May, C. Boudon, J.-P. Gisselbrecht, M. Gross, I. Biaggio, F. Diederich, *Chem. Eur. J.* **2007**, *13*, 5378–5387.
- [61] a) G. Jiang, T. Michinobu, W. Yuan, M. Feng, Y. Wen, S. Du, H. Gao, L. Jiang, Y. Song, F. Diederich, D. Zhu, *Adv. Mater.* **2005**, *17*, 2170–2173; b) J. C. May, I. Biaggio, F. Bureš, F. Diederich, *Appl. Phys. Lett.* **2007**, *90*, 251106; d) F. Bureš, O. Pytela, M. Kivala, F. Diederich, *J. Phys. Org. Chem.* **2011**, *24*, 274–281; e) M. G. Kuzyk, *J. Mater. Chem.* **2009**, *19*, 7444–7465.
- [62] a) H. S. Nalwa, K. Nakajima, T. Watanabe, K. Nakamura, A. Yamada, S. Miyata, *Jpn. J. Appl. Phys.* **1991**, *30*, 983–989; b) H. S. Nalwa, T. Watanabe, S. Miyata, *Adv. Mater.* **1995**, *7*, 754–758; c) H. S. Nalwa, T. Watanabe, K. Ogino, H. Sato, S. Miyata, *J. Mater. Sci.* **1998**, *33*, 3699–3710.
- [63] a) T. Kinnibrugh, S. Bhattacharjee, P. Sullivan, C. Isborn, B. H. Robinson, B. E. Eichinger, *J. Phys. Chem. B* **2006**, *110*, 13512–13522; b) H.-P. Li, K. Han, G. Tang, X.-P. Shen, H.-T. Wang, Z.-M. Huang, Z.-H. Zhang, L. Bai, Z.-Y. Wang, *Chem. Phys. Lett.* **2007**, *444*, 80–84; c) H.-P. Li, K. Han, C.-Y. Wang, X.-P. Shen, H.-T. Wang, G. Tang, *J. Mol. Struct. THEOCHEM* **2008**, *870*, 49–52; d) P.-W. Liu, K. Zhao, G.-C. Han, *Chem. Phys. Lett.* **2011**, *514*, 226–233.
- [64] a) H. Kang, P. Zhu, Y. Yang, A. Facchetti, T. J. Marks, *J. Am. Chem. Soc.* **2004**, *126*, 15974–15975; b) H. Kang, G. Evmenenko, P. Dutta, K. Clays, K. Song, T. J. Marks, *J. Am. Chem. Soc.* **2006**, *128*, 6194–6205.

- [65] a) A. J. Zuccherro, P. L. McGrier, U. H. F. Bunz, *Acc. Chem. Res.* **2010**, *43*, 397–408; b) J. Tolosa, K. M. Solntsev, L. M. Tolbert, U. H. F. Bunz, *J. Org. Chem.* **2010**, *75*, 523–534; c) E. A. Davey, A. J. Zuccherro, O. Trapp, U. H. F. Bunz, *J. Am. Chem. Soc.* **2011**, *133*, 7716–7718; d) M. N. Gard, A. J. Zuccherro, G. Kuzmanich, C. Oelsner, D. Guldi, A. Dreuw, U. H. F. Bunz, M. A. Garcia-Garibay, *Org. Lett.* **2012**, *14*, 1000–1003; e) P. L. McGrier, K. M. Solntsev, S. Miao, L. M. Tolbert, O. R. Miranda, V. M. Rotello, U. H. F. Bunz, *Chem. Eur. J.* **2008**, *14*, 4503–4510; f) M. Hauck, J. Schönhaber, A. J. Zuccherro, K. I. Hardcastle, T. J. J. Müller, U. H. F. Bunz, *J. Org. Chem.* **2007**, *72*, 6417–6725; g) A. J. Zuccherro, J. N. Wilson, U. H. F. Bunz, *J. Am. Chem. Soc.* **2006**, *128*, 11872–11881; h) J. N. Wilson, K. I. Hardcastle, M. Josowicz, U. H. F. Bunz, *Tetrahedron* **2004**, *60*, 7157–7167.
- [66] a) J. A. Marsden, J. J. Miller, L. D. Shirtcliff, M. M. Haley, *J. Am. Chem. Soc.* **2005**, *127*, 2464–2476; b) A. D. Slepko, F. A. Hegmann, R. R. Tykwinski, K. Kamada, K. Ohta, J. A. Marsden, E. L. Spitler, J. J. Miller, M. M. Haley, *Opt. Lett.* **2006**, *31*, 3315–3317; c) E. L. Spitler, L. D. Shirtcliff, M. M. Haley, *J. Org. Chem.* **2007**, *72*, 86–96; d) S. Samori, S. Tojo, M. Fujitsuka, E. I. Spitler, M. M. Haley, T. Majima, *J. Org. Chem.* **2007**, *72*, 2785–2793; e) D. T. Chase, B. S. Young, M. M. Haley, *J. Org. Chem.* **2011**, *76*, 4043–4051.
- [67] L. Dokládlová, F. Bureš, W. Kuznik, I. V. Kityk, A. Wojciechowski, T. Mikysek, N. Almonasy, M. Ramaiyan, Z. Padělková, J. Kulhánek, M. Ludwig, *Org. Biomol. Chem.* **2014**, *12*, 5517–5527.
- [68] F. Bureš, H. Čermáková, J. Kulhánek, M. Ludwig, W. Kuznik, I. V. Kityk, T. Mikysek, A. Růžicka, *Eur. J. Org. Chem.* **2012**, 529–538.
- [69] a) N. Almonasy, F. Bureš, M. Nepraš, H. Přichystalová, G. Grampp, *Dyes Pigm.* **2014**, *108*, 50–56; b) J. Kulhánek, F. Bureš, M. Ludwig, *Beilstein J. Org. Chem.* **2009**, *5*, No. 11.
- [70] Y. Zhao, C. Zhang, K. F. Chin, O. Pytela, G. Wei, H. Liu, F. Bureš, Z. Jiang, *RSC Adv.* **2014**, *4*, 30062–30067.
- [71] X. Liu, X. Ye, F. Bureš, H. Liu, Z. Jiang, *Angew. Chem. Int. Ed.* **2015**, *54*, 11443–11447.
- [72] a) Q. Anjun, K. Hu, L. Shaojun, Y. Cheng, *Synth. Met.* **2003**, *137*, 1517–1518; b) A. Qin, Z. Yang, F. Bai, C. Ye, *J. Polym. Sci. A1* **2003**, *41*, 2846–2853; c) A. Qin, F. Bai, C. Ye, *J. Mol. Struct. THEOCHEM* **2003**, *631*, 79–85.
- [73] a) H. Kang, S. Li, P. Wang, W. Wu, C. Ye, *Synth. Met.* **2001**, *121*, 1469–1470; b) Z. Yang, S. Li, C. Ye, *Synth. Met.* **2003**, *137*, 1519–1520; c) S. Li, Z. Yang, C. Ye, *Chin. J. Polym. Sci.* **2004**, *22*, 453–457; d) P. Wang, P. Zhu, W. Wu, H. Kang, C. Ye, *Phys. Chem. Chem. Phys.* **1999**, *1*, 3519–3525.
- [74] a) A. Janiga, D. Bednarska, B. Thorsted, J. Brewer, D. T. Gryko, *Org. Biomol. Chem.* **2014**, *12*, 2874–2881; b) R. Orłowski, M. Banasiewicz, G. Clermont, F. Castet, R. Nazir, M. Blanchard-Desce, D. T. Gryko, *Phys. Chem. Chem. Phys.* **2015**, *17*, 23724–23731.
- [75] a) X. Sun, Y. Liu, S. Chen, W. Qiu, G. Yu, Y. Ma, T. Qi, H. Zhang, X. Xu, D. Zhu, *Adv. Funct. Mater.* **2006**, *16*, 917–925; b) X. Sun, Y. Zhou, W. Wu, Y. Liu, W. Tian, G. Yu, W. Qiu, S. Chen, D. Zhu, *J. Phys. Chem. B* **2006**, *110*, 7702–7707; c) H. Shang, H. Fan, Y. Liu, W. Hu, Y. Li, X. Zhan, *J. Mater. Chem.* **2011**, *21*, 9667–9673; d) S. Bibi, P. Li, J. Zhang, *J. Mater. Chem. A* **2013**, *1*, 13828–13841.
- [76] a) J. E. Klarke, G. S. Tulevski, K. Sugo, A. de Picciotto, K. A. White, C. Nuckolls, *J. Am. Chem. Soc.* **2003**, *125*, 6030–6031; b) J. E. Klarke, G. S. Tulevski, C. Nuckolls, *Langmuir* **2004**, *20*, 10068–10072; c) G. M. Florio, J. E. Klarke, M. O. Pasamba, T. L. Werblowsky, M. Hyers, B. J. Berne, M. S. Hybertsen, C. Nuckolls, G. W. Flynn, *Langmuir* **2006**, *22*, 10003–10008.
- [77] a) J. Lim, T. A. Albright, B. R. Martin, O. S. Miljanić, *J. Org. Chem.* **2011**, *76*, 10207–10219; b) M. A. Saeed, H. T. M. Le, O. Š. Miljanić, *Acc. Chem. Res.* **2014**, *47*, 2074–2083; c) H. T. M. Le, N. S. El-Hamdi, O. Š. Miljanić, *J. Org. Chem.* **2015**, *80*, 5210–5217.
- [78] a) X. Wang, J. Yan, Y. Zhou, J. Pei, *J. Am. Chem. Soc.* **2010**, *132*, 15872–15874; b) Q. Zhang, R. Tang, X. Sun, Y. Fu, X. Wang, F. Qiu, W. Zhao, S. Han, W. Wang, X. Zhuang, F. Zhang, *Tetrahedron Lett.* **2015**, *56*, 4011–4015.
- [79] a) K. H. Jung, S. Y. Bae, K. H. Kim, M. J. Cho, K. Lee, Z. H. Kim, D. H. Choi, D. H. Lee, D. S. Chung, C. E. Park, *Chem. Commun.* **2009**, 5290–5292; b) H. C. Zhang, E. Q. Guo, Y. L. Zhang, P. H. Ren, W. J. Yang, *Chem. Mater.* **2009**, *21*, 5125–5135; c) D. Zhang, Y. Gao, J. Dong, Q. Sun, W. Liu, S. Xue, W. Yang, *Dyes Pigm.* **2015**, *113*, 307–311.
- [80] a) H. Zhang, Y. Wang, K. Shao, Y. Liu, S. Chen, W. Qiu, X. Sun, T. Qi, Y. Ma, G. Yu, Z. Su, D. Zhu, *Chem. Commun.* **2006**, 755–757; b) J. You, G. Lia, R. Wang, Q. Nie, Z. Wang, J. Li, *Phys. Chem. Chem. Phys.* **2011**, *13*, 17825–17830; c) Z. Jin, D. Wang, X. Wang, P. Liang, Y. Mi, H. Yang, *Tetrahedron Lett.* **2013**, *54*, 4859–4864; d) K. R. Idzik, P. Ledwon, T. Licha, W. Kuznik, M. Lapkowski, J. Frydel, *Dyes Pigm.* **2014**, *103*, 55–61.
- [81] a) C.-H. Lee, K. N. Plunkett, *Org. Lett.* **2013**, *15*, 1202–1205; b) J.-B. Giguère, J. Boismenu-Lavoie, J.-F. Morin, *J. Org. Chem.* **2014**, *79*, 2404–2418.
- [82] a) F. Bureš, W. B. Schweizer, C. Boudon, J.-P. Gisselbrecht, M. Gross, F. Diederich, *Eur. J. Org. Chem.* **2008**, 994–1004; b) Y.-L. Wu, F. Bureš, P. D. Jarowski, W. B. Schweizer, C. Boudon, J.-P. Gisselbrecht, F. Diederich, *Chem. Eur. J.* **2010**, *16*, 9592–9605.
- [83] Y.-L. Wu, F. Tancini, W. B. Schweizer, D. Paunescu, C. Boudon, J.-P. Gisselbrecht, P. D. Jarowski, E. Dalcanale, F. Diederich, *Chem. Asian J.* **2012**, *7*, 1185–1190.
- [84] A. Patel, F. Bureš, M. Ludwig, J. Kulhánek, O. Pytela, A. Růžicka, *Heterocycles* **2009**, *78*, 999–1013.
- [85] a) J. Kulhánek, F. Bureš, O. Pytela, T. Mikysek, J. Ludvík, A. Růžicka, *Dyes Pigm.* **2010**, *85*, 57–65; b) F. Bureš, J. Kulhánek, T. Mikysek, J. Ludvík, J. Lokaj, *Tetrahedron Lett.* **2010**, *51*, 2055–2058; c) J. Lokaj, J. Moncol, F. Bureš, J. Kulhánek, *J. Chem. Crystallogr.* **2011**, *41*, 834–837; d) J. Kulhánek, F. Bureš, W. Kuznik, I. V. Kityk, T. Mikysek, A. Růžicka, *Chem. Asian J.* **2013**, *8*, 465–475.
- [86] J. Kulhánek, F. Bureš, T. Mikysek, J. Ludvík, O. Pytela, *Dyes Pigm.* **2011**, *90*, 48–55.

- [87] J. Kulhánek, F. Bureš, O. Pytela, T. Mikysek, J. Ludvík, *Chem. Asian J.* **2011**, *6*, 1604–1612.
- [88] a) J. Kulhánek, F. Bureš, A. Wojciechowski, M. Makowska-Janusik, E. Gondek, I. V. Kityk, *J. Phys. Chem. A* **2010**, *114*, 9440–9446; b) M. Nepraš, N. Almonasy, F. Bureš, J. Kulhánek, M. Dvořák, M. Michl, *Dyes Pigm.* **2011**, *91*, 466–473; c) M. Makowska-Janusik, I. V. Kityk, J. Kulhánek, F. Bureš, *J. Phys. Chem. A* **2011**, *115*, 12251–12258; d) M. Danko, P. Hrdlovič, J. Kulhánek, F. Bureš, *J. Fluoresc.* **2011**, *21*, 1779–1787; e) M. Danko, F. Bureš, J. Kulhánek, P. Hrdlovič, *J. Fluoresc.* **2012**, *22*, 1165–1176.
- [89] A. Plaquet, B. Champagne, J. Kulhánek, F. Bureš, E. Bogdan, F. Castet, L. Ducasse, V. Rodriguez, *ChemPhysChem* **2011**, *12*, 3245–3252.
- [90] N. Almonasy, F. Bureš, J. Kulhánek, O. Machalický, *J. Mater. Sci. Eng. A* **2011**, *1*, 146–151.
- [91] M. Pokladko-Kowar, N. Nosidlak, E. Gondek, I. V. Kityk, F. Bureš, J. Kulhánek, P. Karasiński, *Opt. Quantum Electron.* **2016**, *48*, 82.
- [92] C. R. Moylan, R. D. Miller, R. J. Twieg, K. M. Betterton, V. Y. Lee, T. J. Matray, C. Nguyen, *Chem. Mater.* **1993**, *5*, 1499–1508.
- [93] a) J. Santos, E. A. Mintz, O. Zehnder, C. Bosshard, X. R. Bu, P. Günter, *Tetrahedron Lett.* **2001**, *42*, 805–808; b) S. Wang, L. Zhao, Z. Xu, C. Wu, S. Cheng, *Mater. Lett.* **2002**, *56*, 1035–1038; c) W. Wang, C. Ye, D. Wang, *ARKIVOC* **2003**, *ii*, 59–69; d) G. Ozturk, D. Karakas, F. Karadag, G. Ozturk, C. Yorgun, *J. Fluoresc.* **2012**, *22*, 1159–1164; e) J. Pina, J. S. Seixas de Melo, R. M. F. Batista, S. P. G. Costa, M. M. M. Raposo, *J. Phys. Chem. B* **2010**, *114*, 4964–4972; f) E. Oliveira, R. M. F. Baptista, S. P. G. Costa, M. M. M. Raposo, C. Lodeiro, *Inorg. Chem.* **2010**, *49*, 10847–10857; g) R. M. F. Batista, S. P. G. Costa, M. Belsley, M. M. M. Raposo, *Dyes Pigm.* **2009**, *80*, 329–336; h) R. M. F. Batista, S. P. G. Costa, M. Belsley, C. Lodeiro, M. M. M. Raposo, *Tetrahedron* **2008**, *64*, 9230–9238.
- [94] a) K. Feng, L. De Boni, L. Misoguti, C. R. Mendonça, M. Meador, F.-L. Hsu, X. R. Bu, *Chem. Commun.* **2004**, 1178–1180; b) K. Feng, F.-L. Hsu, D. Van DerVeer, K. Bota, X. R. Bu, *J. Photochem. Photobiol. A* **2004**, *165*, 223–228; c) L. De Boni, D. L. Silva, U. M. Neves, K. Feng, M. Meador, X. R. Bu, L. Misoguti, C. R. Mendonça, *Chem. Phys. Lett.* **2005**, *402*, 474–478; d) J. Ren, S.-M. Wang, L.-F. Wu, Z.-X. Xu, B.-H. Dong, *Dyes Pigm.* **2008**, *76*, 310–314.
- [95] a) A. Fülöpová, P. Magdolen, M. Károlyiová, I. Sigmundová, P. Zahradník, *J. Heterocycl. Chem.* **2013**, *50*, 563–567; b) E. Aqad, M. V. Lakshminantham, M. P. Cava, R. M. Metzger, *J. Org. Chem.* **2005**, *70*, 768–775.
- [96] a) T. Manifar, S. Rohani, *Can. J. Chem. Eng.* **2004**, *84*, 323–334; b) Y. N. Luponosov, A. N. Solodukhin, S. A. Ponomarenko, *Polym. Sci.* **2014**, *56*, 104–134; c) Z. Ning, H. Tian, *Chem. Commun.* **2009**, 5483–5495; d) A. Mahmood, *Sol. Energy* **2016**, *123*, 127–144; e) J. Pina, J. S. Seixas de Melo, R. M. F. Batista, S. P. G. Costa, M. M. M. Raposo, *J. Org. Chem.* **2013**, *78*, 11389–11395.
- [97] D. Cvejn, E. Michail, I. Polyzos, N. Almonasy, O. Pytela, M. Klikar, T. Mikysek, V. Giannetas, M. Fakis, F. Bureš, *J. Mater. Chem. C* **2015**, *3*, 7345–7355.
- [98] D. Cvejn, E. Michail, K. Seintis, M. Klikar, O. Pytela, T. Mikysek, N. Almonasy, M. Ludwig, V. Giannetas, M. Fakis, F. Bureš, *RSC Adv.* **2016**, *6*, 12819–12828.
- [99] D. Cvejn, S. Achelle, O. Pytela, J.-P. Malval, A. Spangenberg, A. Cabon, F. Bureš, F. Robin-le Guen, *Dyes Pigm.* **2016**, *124*, 101–109.
- [100] K. Melánová, D. Cvejn, F. Bureš, V. Zima, J. Svoboda, L. Beneš, T. Mikysek, O. Pytela, P. Knotek, *Dalton Trans.* **2014**, *43*, 10462–10470.
- [101] a) M.-H. Ha-Thi, V. Souchon, A. Hamdi, R. Métivier, V. Alain, K. Nakatani, P. G. Lacroix, J.-P. Genêt, V. Michelet, I. Leray, *Chem. Eur. J.* **2006**, *12*, 9056–9065; b) S. Yamaguchi, T. Shirasaka, K. Tamao, *Org. Lett.* **2000**, *2*, 4129–4132; c) Y. Liu, X. Xu, F. Zheng, Y. Cui, *Angew. Chem. Int. Ed.* **2008**, *47*, 4538–4541; d) J. Yoshino, Y. Nakamura, S. Kunitomo, N. Hayashi, H. Higuchi, *Tetrahedron Lett.* **2013**, *54*, 2817–2820.
- [102] a) L. Porrès, C. Katan, O. Mongin, T. Pons, J. Mertz, M. Blanchard-Desce, *J. Mol. Struct.* **2004**, *704*, 17–24; b) M. M. Oliva, J. Casado, J. T. L. Navarrete, G. Hennrich, S. van Cleuvenbergen, I. Asselberghs, K. Clays, M. C. R. Delgado, J.-L. Brédas, J. S. S. de Melo, L. De Cola, *Chem. Eur. J.* **2009**, *15*, 8223–8234; c) H.-F. Huang, S.-H. Xu, Y.-B. He, C.-C. Zhu, H.-L. Fan, X.-H. Zhou, X.-C. Gao, Y.-F. Dai, *Dyes Pigm.* **2013**, *96*, 705–713; d) S. Pelz, J. Zhang, I. Kanelidis, D. Klink, L. Hyzak, V. Wulf, O. J. Schmitz, J.-C. Gasse, R. Frahm, A. Pütz, A. Colsmann, U. Lemmer, E. Holder, *Eur. J. Org. Chem.* **2013**, 4761–4769; e) F.-A. Martin, C. Baudequin, C. Fiol-Petit, M. Darabantu, Y. Ramondenc, N. Plé, *Tetrahedron* **2014**, *70*, 2546–2555; f) T. Shimasaki, Y. Takiyama, Y. Nishihara, A. Morimoto, N. Teramoto, M. Shibata, *Tetrahedron Lett.* **2015**, *56*, 260–263; g) S. Varghese, N. S. S. Kumar, A. Krishna, D. S. S. Rao, S. K. Prasad, S. Das, *Adv. Funct. Mater.* **2009**, *19*, 2064–2073; h) C. C. Paraschivescu, N. D. Hădăde, A. G. Coman, A. Gautier, F. Cisnetti, M. Matache, *Tetrahedron Lett.* **2015**, *56*, 3961–3964; i) M.-S. Yuan, Q. Wang, W.-J. Wang, T.-B. Li, L. Wang, W. Deng, Z.-T. Du, J.-R. Wang, *Dyes Pigm.* **2012**, *95*, 236–243.
- [103] C. K. R. Namboodiri, P. B. Bisht, R. Mukkamala, B. Chandra, I. S. Aidhen, *Chem. Phys.* **2013**, *415*, 190–195.
- [104] S. Achelle, Y. Ramondenc, G. Dupas, N. Plé, *Tetrahedron* **2008**, *64*, 2783–2791.
- [105] a) Y. Z. Cui, Q. Fang, A. H. Lei, G. Xue, W. T. Yu, *Chem. Phys. Lett.* **2003**, *377*, 507–511; b) L. Liu, Z. Q. Zhou, J. P. Shi, C. G. Lu, Y. P. Cui, G. Y. Lu, *Chin. Chem. Lett.* **2011**, *22*, 1147–1150; c) L. Wei, J. P. Shi, Z. Q. Zhou, Y. P. Cui, H. W. Hu, G. Y. Lu, *Chin. Chem. Lett.* **2012**, *23*, 867–870; d) L. Zou, Z. Liu, X. Yan, Y. Liu, Y. Fu, J. Liu, Z. Huang, X. Chen, J. Qin, *Eur. J. Org. Chem.* **2009**, 5587–5593; e) T. Yasuda, T. Shimizu, F. Liu, G. Ungar, T. Kato, *J. Am. Chem. Soc.* **2011**, *133*, 13437–13444; f) G. Argouarch, R. Veillard, T. Roisnel, A. Amar, H. Meghezzi, A. Boucekkine, V. Hugues, O.

Mongin, M. Blanchard-Desce, F. Paul, *Chem. Eur. J.* **2012**, *18*, 11811–11827; g) J. Liu, K. Wang, F. Xu, Z. Tang, W. Zheng, J. Zhang, C. Li, T. Yu, X. You, *Tetrahedron Lett.* **2011**, *52*, 6492–6496; h) V. S Padalkar, V. S Patil, N. Sekar, *Chem. Cent. J.* **2011**, *5*, 77; i) Y. Jiang, Y. Wang, B. Wang, J. Yang, N. He, S. Qian, J. Hua, *Chem. Asian J.* **2011**, *6*, 157–

165; j) Y. Jiang, Y. Wang, J. Hua, J. Tang, B. Li, S. Qian, H. Tian, *Chem. Commun.* **2010**, *46*, 4689–4691.